

RETURN WITH BID



Illinois Department of Transportation

Local Public Agency
Material Proposal or
Deliver & Install Proposal

PROPOSAL SUBMITTED BY		
Contractor's Name		
Street	P.O. Box	
City	State	Zip Code

STATE OF ILLINOIS

COUNTY OF DeKalb
Various Road Districts
 (Name of City, Village, Town or Road District)

FOR THE IMPROVEMENT OF

STREET NAME OR ROUTE NO. Various
 SECTION NO. 17-XX000-00-GM
 TYPES OF FUNDS MFT & Local

- MATERIAL PROPOSAL DELIVER & INSTALL PROPOSAL
 SPECIFICATIONS (required) PLANS (if applicable)

For Municipal Projects
 Submitted/Approved/Passed

Mayor President of Board of Trustees Municipal Official

Date

Department of Transportation
 Released for bid based on limited review

Kevin Hamble
 Regional Engineer

2/1/17
 Date

For County and Road District Projects
 Submitted/Approved

 Highway Commissioner

 Date

Submitted/Approved
DA

 County Engineer/Superintendent of Highways

1-31-17
 Date

Note: All proposal documents, including Proposal Guaranty Checks or Proposal Bid Bonds, should be stapled together to prevent loss when bids are processed.

RETURN WITH BID

NOTICE TO BIDDERS

County DeKalb
Local Public Agency Various
Section Number 17-XX000-00-GM
Route Various

Sealed proposals for the furnishing or delivering & installing materials required in the construction/maintenance of the above Section will be received and at that time publicly opened and read at the office of the DeKalb County Engineer,

1826 Barber Greene Road, DeKalb, IL 60115 until 8:30 AM on March 1, 2017
Address Time Date

- 1. Plans and proposal forms will be available in the office of the DeKalb County Engineer 1826 Barber Greene Road, DeKalb, IL 60115
2. Prequalification. If checked, the 2 low bidders must file within 24 hours after the letting an "Affidavit of Availability" (Form BC 57), in duplicate, showing all uncompleted contracts awarded to them and all low bids pending award for Federal, State, County, Municipal and private work.
3. The Awarding Authority reserves the right to waive technicalities and to reject any or all proposals as provided in BLRS Special Provision for Bidding Requirements and Conditions for Material Proposals.
4. A proposal guaranty in the proper amount, as specified in BLRS Special Provision for Bidding Requirements and Conditions for Material Proposals, will be required. Bid Bonds will not be allowed as a proposal guaranty.
5. The successful bidder at the time of execution of the contract will not be required to deposit a contract bond for the full amount of the award. When a contract bond is not required, the proposal guaranty check will be held in lieu thereof. Failure on the part of the contractor to deliver the material within the time specified or to do the work specified herein will be considered just cause to forfeit his surety as provided in Article 108.10 of the Standard Specifications.
6. Proposals shall be submitted on forms furnished by the Awarding Authority and shall be enclosed in an envelope endorsed "Material Proposal, Section 17-XX000-00-GM".

By Order of DeKalb County Board 12/13/2016 Nathan F. Schwartz, P.E.
(Awarding Authority) Date (County Engineer/Superintendent of Highways/Municipal Clerk)

Material Proposal or Deliver & Install Proposal

To DeKalb County Board
(Awarding Authority)

If this bid is accepted within 45 days from date of opening, the undersigned agrees to furnish or to deliver & install any or all of the materials, at the quoted unit prices, subject to the following:

- 1. It is understood and agreed that the "Standard Specifications for Road and Bridge Construction", adopted April 1, 2016, and the "Supplemental Specifications and Recurring Special Provisions", adopted January 1, 2017, prepared by the Department of Transportation, shall govern insofar as they may be applied and insofar as they do not conflict with the special provisions and supplemental specifications attached hereto.
2. It is understood that quantities listed are approximate only and that they may be increased or decreased as may be needed to properly complete the improvement within its present limits or extensions thereto, at the unit price stated and that bids will be compared on the basis of the total price bid for each group.
3. Delivery in total or partial shipments as ordered shall be made within the time specified in the special provisions or by the acceptance at the point and in the manner specified in the "Schedule of Prices". If delivery on the job site is specified, it shall mean any place or places on the road designated by the awarding authority or its authorized representative.
4. The contractor and/or local agency performing the actual material placement operations shall be responsible for providing work zone traffic control, unless otherwise specified in this proposal. Such devices shall meet the requirements of and be installed in accordance with applicable provisions of the "Illinois Manual on Uniform Traffic Control Devices" and any referenced Illinois Highway Standards.
5. Each pay item should have a unit price and a total price. If no total price is shown or if there is a discrepancy between the product of the unit price multiplied by the quantity, the unit price shall govern. If a unit price is omitted, the total price will be divided by the quantity in order to establish a unit price. A bid will be declared unacceptable if neither a unit price nor a total price is shown.

Discounts will be allowed for payment as follows: 0 % 0 calendar days: 0 % 0 calendar days.

Discounts will not be considered in determining the low bidder.

Bidder By
Address Title
(Signature)



Affidavit of Illinois Business Office

County DeKalb
Local Public Agency Various
Section Number 17-XX000-00-GM
Route Various

State of _____)
) ss.
County of _____)

I, _____ of _____, _____,
(Name of Affiant) (City of Affiant) (State of Affiant)

being first duly sworn upon oath, states as follows:

- 1. That I am the _____ of _____ bidder.
officer or position
2. That I have personal knowledge of the facts herein stated.
3. That, if selected under this proposal, _____, will maintain a
(bidder)
business office in the State of Illinois which will be located in _____ County, Illinois.
4. That this business office will serve as the primary place of employment for any persons employed in the
construction contemplated by this proposal.
5. That this Affidavit is given as a requirement of state law as provided in Section 30-22(8) of the Illinois
Procurement Code.

(Signature)

(Print Name of Affiant)

This instrument was acknowledged before me on _____ day of _____, _____.

(SEAL)

(Signature of Notary Public)



Group No.	Items	Delivery	Unit	Quantity	Unit Price	Total
1	Agg Surf Cse, CA-6 (Squaw Grove Twp)	SOR at Jobsite	Ton	3000.00		
2	Agg Surf Cse, CA-6 (Victor Twp)	SOR at Jobsite	Ton	8020.00		

The undersigned firm certifies that it has not been convicted of bribery or attempting to bribe an officer or employee of the State of Illinois, nor has the firm made an admission of guilt of such conduct which is a matter of record, nor has an official, agent or employee of the firm committed bribery or attempted bribery on behalf of the firm and pursuant to the direction or authorization of a responsible official of the firm. The undersigned firm further certifies that it is not barred from contracting with any unit of State or local government as a result of a violation of State laws prohibiting bid-rigging or bid rotating.

Signature of Bidder

Address

The following Special Provisions supplement the “Standard Specifications for Road and Bridge Construction”, Adopted April 1, 2016 _____, the latest edition of the “Manual on Uniform Traffic Control Devices for Streets and Highways”, and the “Manual of Test Procedures of Materials” in effect on the date of invitation of bids, and the Supplemental Specifications and Recurring Special Provisions indicated on the Check Sheet included here in which apply to and govern the construction of Section 17-XX000-00-GM _____, and in case of conflict with any part, or parts, of said Specifications, the said Special Provisions shall take precedence and shall govern.

DESCRIPTION OF WORK The work of this section shall consist of furnishing approximately 11,020 tons of maintenance aggregate S.O.R. on various roads in DeKalb County.

PREQUALIFICATION OF BIDDERS The provisions for prequalification of bidders as stated in LRS#7 shall not apply to this proposal.

AGGREGATE SURFACE COURSE, CA-6, TYPE B The material shall meet the requirements of Section 402 of the Standard Specifications with the following exceptions:

402.02(1004.04) Materials: The material shall be limited to gradation CA-06.

402.07 A spreader box will not be required; but the method of spreading shall meet the approval of the Engineer. Final blading will be done by Township forces.

402.13 Basis of Payment: The material will be paid for at the contract unit price per ton for Aggregate Surface Course, CA-6, Type B.

Group 1) 3000 tons of CA-6 is scheduled to be S.O.R. on various roads in Squaw Grove Township (see location map).

Group 2) 8020 tons of CA-6 is scheduled to be S.O.R. for various roads in Victor Township (see location map).

PROPOSAL GUARANTY Each proposal shall be accompanied by a bank cashier’s check or a properly certified check as per LRS#7. The proposal guaranty shall be held as contract guaranty until the project is complete. 5% Retainage will be withheld from progress payments until the project is completed as specified.

DELIVERY OF MATERIAL Quantities shown on this proposal are approximate. The Road Commissioner reserves the right to order only such quantities as may be required in 2017. Delivery of S.O.R. materials will be made to the jobsite (see location maps) upon request of the Township Road Commissioner.

TRAFFIC CONTROL Traffic Control will be performed by the Township.

GROUP AWARDS Bidders may bid on any or all of the groups. Awards shall be made separately for each group. For determination of the F.O.B. material awards, the haul rate shall be figured from the center of the various roads on which the material is to be used. The haul rate of \$1.40 for the first mile and \$0.30 for each additional mile will be used to determine the low bid.

GENERAL CONDITIONS This work shall be completed by August 31, 2017.

INDEX
FOR
SUPPLEMENTAL SPECIFICATIONS
AND RECURRING SPECIAL PROVISIONS

Adopted January 1, 2017

This index contains a listing of SUPPLEMENTAL SPECIFICATIONS, frequently used RECURRING SPECIAL PROVISIONS, and LOCAL ROADS AND STREETS RECURRING SPECIAL PROVISIONS.

ERRATA Standard Specifications for Road and Bridge Construction
(Adopted 4-1-16) (Revised 1-1-17)

SUPPLEMENTAL SPECIFICATIONS

<u>Std. Spec. Sec.</u>		<u>Page No.</u>
106	Control of Materials	1
403	Bituminous Surface Treatment (Class A-1, A-2, A-3)	2
420	Portland Cement Concrete Pavement	3
502	Excavation for Structures	5
503	Concrete Structures	7
504	Precast Concrete Structures	10
542	Pipe Culverts	11
586	Sand Backfill for Vaulted Abutments	12
670	Engineer's Field Office and Laboratory	14
704	Temporary Concrete Barrier	15
888	Pedestrian Push-Button	17
1003	Fine Aggregates	18
1004	Coarse Aggregates	19
1006	Metals	21
1020	Portland Cement Concrete	22
1103	Portland Cement Concrete Equipment	24

BDE SPECIAL PROVISIONS
For the January 20 and March 10, 2017 Lettings

The following special provisions indicated by an "x" are applicable to this contract and will be included by the Project Development and Implementation Section of the BD&E. An * indicates a new or revised special provision for the letting.

<u>File Name</u>	<u>#</u>	<u>Special Provision Title</u>	<u>Effective</u>	<u>Revised</u>
80099	1	Accessible Pedestrian Signals (APS)	April 1, 2003	Jan. 1, 2014
80274	2	Aggregate Subgrade Improvement	April 1, 2012	April 1, 2016
80192	3	Automated Flagger Assistance Device	Jan. 1, 2008	
80173	4	Bituminous Materials Cost Adjustments	Nov. 2, 2006	July 1, 2015
80241	5	Bridge Demolition Debris	July 1, 2009	
5026I	6	Building Removal-Case I (Non-Friable and Friable Asbestos)	Sept. 1, 1990	April 1, 2010
5048I	7	Building Removal-Case II (Non-Friable Asbestos)	Sept. 1, 1990	April 1, 2010
5049I	8	Building Removal-Case III (Friable Asbestos)	Sept. 1, 1990	April 1, 2010
5053I	9	Building Removal-Case IV (No Asbestos)	Sept. 1, 1990	April 1, 2010
80366	10	Butt Joints	July 1, 2016	
80198	11	Completion Date (via calendar days)	April 1, 2008	
80199	12	Completion Date (via calendar days) Plus Working Days	April 1, 2008	
80293	13	Concrete Box Culverts with Skews > 30 Degrees and Design Fills ≤ 5 Feet	April 1, 2012	July 1, 2016
80311	14	Concrete End Sections for Pipe Culverts	Jan. 1, 2013	April 1, 2016
80277	15	Concrete Mix Design – Department Provided	Jan. 1, 2012	April 1, 2016
80261	16	Construction Air Quality – Diesel Retrofit	June 1, 2010	Nov. 1, 2014
80029	17	Disadvantaged Business Enterprise Participation	Sept. 1, 2000	July 2, 2016
* 80378	18	Dowel Bar Inserter	Jan. 1, 2017	
80229	19	Fuel Cost Adjustment	April 1, 2009	July 1, 2015
80304	20	Grooving for Recessed Pavement Markings	Nov. 1, 2012	Aug. 1, 2014
80246	21	Hot-Mix Asphalt – Density Testing of Longitudinal Joints	Jan. 1, 2010	April 1, 2016
80347	22	Hot-Mix Asphalt – Pay for Performance Using Percent Within Limits – Jobsite Sampling	Nov. 1, 2014	April 1, 2016
80376	23	Hot-Mix Asphalt – Tack Coat	Nov. 1, 2016	
80367	24	Light Poles	July 1, 2016	
80368	25	Light Tower	July 1, 2016	
80336	26	Longitudinal Joint and Crack Patching	April 1, 2014	April 1, 2016
80369	27	Mast Arm Assembly and Pole	July 1, 2016	
80045	28	Material Transfer Device	June 15, 1999	Aug. 1, 2014
80165	29	Moisture Cured Urethane Paint System	Nov. 1, 2006	Jan. 1, 2010
80349	30	Pavement Marking Blackout Tape	Nov. 1, 2014	April 1, 2016
80371	31	Pavement Marking Removal	July 1, 2016	
80298	32	Pavement Marking Tape Type IV	April 1, 2012	April 1, 2016
80377	33	Portable Changeable Message Signs	Nov. 1, 2016	
* 80359	34	Portland Cement Concrete Bridge Deck Curing	April 1, 2015	Jan. 1, 2017
80338	35	Portland Cement Concrete Partial Depth Hot-Mix Asphalt Patching	April 1, 2014	April 1, 2016
80300	36	Preformed Plastic Pavement Marking Type D - Inlaid	April 1, 2012	April 1, 2016
80328	37	Progress Payments	Nov. 2, 2013	
3426I	38	Railroad Protective Liability Insurance	Dec. 1, 1986	Jan. 1, 2006
80157	39	Railroad Protective Liability Insurance (5 and 10)	Jan. 1, 2006	
80306	40	Reclaimed Asphalt Pavement (RAP) and Reclaimed Asphalt Shingles (RAS)	Nov. 1, 2012	April 1, 2016
* 80340	41	Speed Display Trailer	April 2, 2014	Jan. 1, 2017
80127	42	Steel Cost Adjustment	April 2, 2004	July 1, 2015
* 80379	43	Steel Plate Beam Guardrail	Jan. 1, 2017	

<u>File Name</u>	<u>#</u>	<u>Special Provision Title</u>	<u>Effective</u>	<u>Revised</u>
80317	44	Surface Testing of Hot-Mix Asphalt Overlays	Jan. 1, 2013	April 1, 2016
20338	45	Training Special Provisions	Oct. 15, 1975	
80318	46	Traversable Pipe Grate	Jan. 1, 2013	April 1, 2014
* 80381	47	Traffic Barrier Terminal, Type 1 Special	Jan. 1, 2017	
* 80380	48	Tubular Markers	Jan. 1, 2017	
80288	49	Warm Mix Asphalt	Jan. 1, 2012	April 1, 2016
80302	50	Weekly DBE Trucking Reports	June 2, 2012	April 2, 2015
80289	51	Wet Reflective Thermoplastic Pavement Marking	Jan. 1, 2012	
80071	52	Working Days	Jan. 1, 2002	

The following special provisions are in the 2017 Supplemental Specifications and Recurring Special Provisions.

<u>File Name</u>	<u>Special Provision Title</u>	<u>New Location</u>	<u>Effective</u>	<u>Revised</u>
80360	Coarse Aggregate Quality	Article 1004.01	July 1, 2015	
80363	Engineer's Field Office	Article 670.07	April 1, 2016	
80358	Equal Employment Opportunity	Recurring CS #1 and #5	April 1, 2015	
80364	Errata for the 2016 Standard Specifications	Supplemental	April 1, 2016	
80342	Mechanical Side Tie Bar Inserter	Articles 420.03, 420.05, and 1103.19	Aug. 1, 2014	April 1, 2016
80370	Mechanical Splicers	Article 1006.10	July 1, 2016	
80361	Overhead Sign Structures Certification of Metal Fabricator	Article 106.08	Nov. 1, 2015	April 1, 2016
80365	Pedestrian Push-Button	Article 888.03	April 1, 2016	
80353	Portland Cement Concrete Inlay or Overlay	Recurring CS #34	Jan. 1, 2015	April 1, 2016
80372	Preventive Maintenance – Bituminous Surface Treatment (A-1)	Recurring CS #28	Jan. 1, 2009	July 1, 2016
80373	Preventive Maintenance – Cape Seal	Recurring CS #29	Jan. 1, 2009	July 1, 2016
80374	Preventive Maintenance – Micro-Surfacing	Recurring CS #30	Jan. 1, 2009	July 1, 2016
80375	Preventive Maintenance – Slurry Seal	Recurring CS #31	Jan. 1, 2009	July 1, 2016
80362	Steel Slag in Trench Backfill	Articles 1003.01 and 1003.04	Jan. 1, 2016	
80355	Temporary Concrete Barrier	Articles 704.02, 704.04, 704.05, and 704.06	Jan. 1, 2015	July 1, 2015

The following special provisions require additional information from the designer. The additional information needs to be included in a separate document attached to this check sheet. The Project Development and Implementation section will then include the information in the applicable special provision. The Special Provisions are:

- Bridge Demolition Debris
- Building Removal-Case I
- Building Removal-Case II
- Building Removal-Case III
- Building Removal-Case IV
- Completion Date
- Completion Date Plus Working Days
- DBE Participation
- Material Transfer Device
- Railroad Protective Liability Insurance
- Training Special Provisions
- Working Days

Check Sheet for Recurring Special Provisions

Adopted January 1, 2017

The following RECURRING SPECIAL PROVISIONS indicated by an "X" are applicable to this contract and are included by reference:

Recurring Special Provisions

<u>Check Sheet #</u>		<u>Page No.</u>
1	<input type="checkbox"/> Additional State Requirements for Federal-Aid Construction Contracts	26
2	<input type="checkbox"/> Subletting of Contracts (Federal-Aid Contracts)	29
3	<input type="checkbox"/> EEO	30
4	<input type="checkbox"/> Specific EEO Responsibilities Non Federal-Aid Contracts	40
5	<input type="checkbox"/> Required Provisions - State Contracts	45
6	<input type="checkbox"/> Asbestos Bearing Pad Removal	51
7	<input type="checkbox"/> Asbestos Waterproofing Membrane and Asbestos Hot-Mix Asphalt Surface Removal	52
8	<input type="checkbox"/> Temporary Stream Crossings and In-Stream Work Pads	53
9	<input type="checkbox"/> Construction Layout Stakes Except for Bridges	54
10	<input type="checkbox"/> Construction Layout Stakes	57
11	<input type="checkbox"/> Use of Geotextile Fabric for Railroad Crossing	60
12	<input type="checkbox"/> Subsealing of Concrete Pavements	62
13	<input type="checkbox"/> Hot-Mix Asphalt Surface Correction	66
14	<input type="checkbox"/> Pavement and Shoulder Resurfacing	68
15	<input type="checkbox"/> Patching with Hot-Mix Asphalt Overlay Removal	69
16	<input type="checkbox"/> Polymer Concrete	70
17	<input type="checkbox"/> PVC Pipeliner	72
18	<input type="checkbox"/> Bicycle Racks	73
19	<input type="checkbox"/> Temporary Portable Bridge Traffic Signals	75
20	<input type="checkbox"/> Work Zone Public Information Signs	77
21	<input type="checkbox"/> Nighttime Inspection of Roadway Lighting	78
22	<input type="checkbox"/> English Substitution of Metric Bolts	79
23	<input type="checkbox"/> Calcium Chloride Accelerator for Portland Cement Concrete	80
24	<input type="checkbox"/> Quality Control of Concrete Mixtures at the Plant	81
25	<input type="checkbox"/> Quality Control/Quality Assurance of Concrete Mixtures	89
26	<input type="checkbox"/> Digital Terrain Modeling for Earthwork Calculations	105
27	<input type="checkbox"/> Reserved	107
28	<input type="checkbox"/> Preventive Maintenance - Bituminous Surface Treatment	108
29	<input type="checkbox"/> Preventive Maintenance - Cape Seal	114
30	<input type="checkbox"/> Preventive Maintenance - Micro-Surfacing	129
31	<input type="checkbox"/> Preventive Maintenance - Slurry Seal	140
32	<input type="checkbox"/> Temporary Raised Pavement Markers	149
33	<input type="checkbox"/> Restoring Bridge Approach Pavements Using High-Density Foam	150
34	<input type="checkbox"/> Portland Cement Concrete Inlay or Overlay	153

**Check Sheet for
Local Roads and Streets Recurring Special Provisions**

Adopted January 1, 2017

The following LOCAL ROADS AND STREETS RECURRING SPECIAL PROVISIONS indicated by an "X" are applicable to this contract and are included by reference:

Local Roads And Streets Recurring Special Provisions

<u>Check Sheet #</u>		<u>Page No.</u>
LRS 1	Reserved	158
LRS 2	<input type="checkbox"/> Furnished Excavation	159
LRS 3	<input type="checkbox"/> Work Zone Traffic Control Surveillance	160
LRS 4	<input type="checkbox"/> Flaggers in Work Zones	161
LRS 5	<input checked="" type="checkbox"/> Contract Claims	162
LRS 6	<input type="checkbox"/> Bidding Requirements and Conditions for Contract Proposals	163
LRS 7	<input checked="" type="checkbox"/> Bidding Requirements and Conditions for Material Proposals	169
LRS 8	Reserved	175
LRS 9	<input type="checkbox"/> Bituminous Surface Treatments	176
LRS 10	Reserved	177
LRS 11	<input checked="" type="checkbox"/> Employment Practices	150
LRS 12	<input checked="" type="checkbox"/> Wages of Employees on Public Works	152
LRS 13	<input checked="" type="checkbox"/> Selection of Labor	154
LRS 14	<input type="checkbox"/> Paving Brick and Concrete Paver Pavements and Sidewalks	155
LRS 15	<input checked="" type="checkbox"/> Partial Payments	158
LRS 16	<input type="checkbox"/> Protests on Local Lettings	159
LRS 17	<input checked="" type="checkbox"/> Substance Abuse Prevention Program	160
LRS 18	<input type="checkbox"/> Multigrade Cold Mix Asphalt	161

State of Illinois
Department of Transportation
Bureau of Local Roads and Streets

SPECIAL PROVISION
FOR
INSURANCE

Effective: February 1, 2007
Revised: August 1, 2007

All references to Sections or Articles in this specification shall be construed to mean specific Section or Article of the Standard Specifications for Road and Bridge Construction, adopted by the Department of Transportation.

The Contractor shall name the following entities as additional insured under the Contractor's general liability insurance policy in accordance with Article 107.27:

DeKalb County

Squaw Grove Township Road District

Victor Township Road District

The entities listed above and their officers, employees, and agents shall be indemnified and held harmless in accordance with Article 107.26.

CHECK SHEET #LRS7

State of Illinois
Department of Transportation
Bureau of Local Roads and Streets

**SPECIAL PROVISION
FOR
BIDDING REQUIREMENTS AND CONDITIONS FOR MATERIAL PROPOSALS**

Effective: January 1, 2002
Revised: January 1, 2013

Replace Article 102.01 of the Standard Specifications with the following:

“Prequalification of Bidders. When prequalification is required and the awarding authority for contract construction work is the County Board of a County, the Council, the City Council, or the President and Board of Trustees of a city, village, or town, each prospective bidder, in evidence of competence, shall furnish the awarding authority as a prerequisite to the release of proposal forms by the awarding authority, a certified or photostatic copy of a "Certificate of Eligibility" issued by the Department of Transportation, in accordance with the Department's "Prequalification Manual".

The two low bidders must file, within 24 hours after the letting, a sworn affidavit in triplicate, showing all uncompleted contracts awarded to them and all low bids pending award for Federal, State, County, Municipal and private work, using the blank form made available for this affidavit. One copy shall be filed with the awarding authority and two copies with the District office.

Issuance of Proposal Forms. The Awarding Authority reserves the right to refuse to issue a proposal form for bidding purposes for any of the following reasons:

- (a) Lack of competency and adequate machinery, plant, and other equipment, as revealed by the financial statement and experience questionnaires required in prequalification procedures.
- (b) Uncompleted work which, in the judgment of the Awarding Authority, might hinder or prevent the prompt completion of additional work awarded.
- (c) False information provided on a bidder's "Affidavit of Availability".
- (d) Failure to pay, or satisfactorily settle, all bills due for labor and material on former contracts in force at the time of issuance of proposal forms.
- (e) Failure to comply with any prequalification regulations of the Department.
- (f) Default under previous contracts.
- (g) Unsatisfactory performance record as shown by past work for the Awarding Authority, judged from the standpoint of workmanship and progress.
- (h) When the Contractor is suspended from eligibility to bid at a public letting where the contract is awarded by, or requires approval of, the Department.

CHECK SHEET #LRS7

- (i) When any agent, servant, or employee of the prospective bidder currently serves as a member, employee, or agent of a governmental body that is financially involved in the proposal work.
- (j) When any agent, servant, or employee of the perspective bidder has participated in the preparation of plans or specifications for the proposed work.

Interpretation of Quantities in the Bid Schedule. The quantities appearing in the bid schedule are approximate and are prepared for the comparison of bids. Payment to the Contractor will be made only for the actual quantities of work performed and accepted or materials furnished according to the contract. The scheduled quantities of work to be done and materials to be furnished may be increased, decreased or omitted as hereinafter provided.

Examination of Material Proposal, Specifications, Special Provisions, and Site of Work. The bidder shall, before submitting a bid, carefully examine the provisions of the proposal. The bidder shall inspect in detail the site of the proposed work, investigate and become familiar with all the local conditions affecting the work and fully acquaint themselves with the detailed requirements of the work. Submission of a bid shall be a conclusive assurance and warranty the bidder has made these examinations and the bidder understands all requirements for the performance of the work. If his/her bid is accepted, the bidder will be responsible for all errors in the proposal resulting from his/her failure or neglect to comply with these instructions. The Awarding Authority will, in no case, be responsible for any costs, expenses, losses, or change in anticipated profits resulting from such failure or neglect of the bidder to make these examinations.

The bidder shall take no advantage of any error or omission in the proposal. Any prospective bidder who desires an explanation or interpretation of the specification, or any of the documents, shall request such in writing from the Awarding Authority, in sufficient time to allow a written reply by the Awarding Authority that can reach all prospective bidders before the submission of their bids. Any reply given a prospective bidder concerning any of the documents and specifications will be furnished to all prospective bidders in the form determined by the Awarding Authority including, but not limited to, an addendum, if the information is deemed by the Awarding Authority to be necessary in submitting bids or if the Awarding Authority concludes the information would aid competition. Oral explanations, interpretations or instructions given before the submission of bids unless at a prebid conference will not be binding on the Awarding Authority.

Preparation of the Proposal. Bidders shall submit their proposals on the form furnished by the Awarding Authority. The proposal shall be executed properly, and bids shall be made for all items indicated in the proposal form, except when alternate bids are asked, a bid on more than one alternate for each item is not required, unless otherwise provided. The bidder shall indicate in figures, a unit price for each of the separate items called for in the proposal form; the bidder shall show the products of the respective quantities and unit prices in the column provided for that purpose, and the gross sum shown in the place indicated in the proposal form shall be the summation of said products. All writing shall be with ink or typewriter, except the signature of the bidder which shall be written in ink.

CHECK SHEET #LRS7

When prequalification is required, the proposal form shall be submitted by an authorized bidder in the same name and style as shown on the "Contractor's Statement of Experience and Financial Condition" used for prequalification and shall be submitted in like manner.

Rejection of Proposals. The Awarding Authority reserves the right to reject any proposal for any of the conditions in "Issuance of Proposal Forms" or for any of the following reasons:

- (a) More than one proposal for the same work from an individual, firm, partnership, or corporation under the same name or different names.
- (b) Evidence of collusion among bidders.
- (c) Unbalanced proposals in which the bid prices for some items are, in the judgment of the Awarding Authority, out of proportion to the bid prices for other items.
- (d) If the proposal does not contain a unit price for each pay item listed, except in the case of authorized alternate pay items or lump sum pay items.
- (e) If the proposal form is other than that furnished by the Awarding Authority; or if the form is altered or any part thereof is detached.
- (f) If there are omissions, erasures, alterations, unauthorized additions, conditional or alternate bids, or irregularities of any kind which may tend to make the proposal incomplete, indefinite or ambiguous as to its meaning.
- (g) If the bidder adds any provisions reserving the right to accept or reject an award, or to enter into a contract pursuant to an award.
- (i) If the proposal is not accompanied by the proper proposal guaranty.
- (i) If the proposal is prepared with other than ink or typewriter, or otherwise fails to meet the requirements of the above "Preparation of Proposal" section.

Proposal Guaranty. Each proposal shall be accompanied by a bid bond on the Department form contained in the proposal, executed by a corporate surety company satisfactory to the Awarding Authority, by a bank cashier's check or a properly certified check for not less than five percent of the amount bid, or for the amount specified in the following schedule:

CHECK SHEET #LRS7

	<u>Amount Bid</u>	<u>Proposal Guaranty</u>
Up to	\$5,000	\$150
>\$5,000	\$10,000	\$300
>\$10,000	\$50,000	\$1,000
>\$50,000	\$100,000	\$3,000
>\$100,000	\$150,000	\$5,000
>\$150,000	\$250,000	\$7,500
>\$250,000	\$500,000	\$12,500
>\$500,000	\$1,000,000	\$25,000
>\$1,000,000	\$1,500,000	\$50,000
>\$1,500,000	\$2,000,000	\$75,000
>\$2,000,000	\$3,000,000	\$100,000
>\$3,000,000	\$5,000,000	\$150,000
>\$5,000,000	\$7,500,000	\$250,000
>\$7,500,000	\$10,000,000	\$400,000
>\$10,000,000	\$15,000,000	\$500,000
>\$15,000,000	\$20,000,000	\$600,000
>\$20,000,000	\$25,000,000	\$700,000
>\$25,000,000	\$30,000,000	\$800,000
>\$30,000,000	\$35,000,000	\$900,000
Over	\$35,000,000	\$1,000,000

In the event that one proposal guaranty check is intended to cover two or more proposals, the amount must equal to the sum of the proposal guaranties which would be required for each individual proposal.

Bank cashier's checks or properly certified checks accompanying proposals shall be made payable to the County Treasurer, when a County is the awarding authority; or the City, Village, or Town Treasurer, when a city, village, or town is the awarding authority.

If this proposal contains various groups and the bidder has the option of bidding on one or several groups, the bidder may provide a separate proposal guaranty for each group or combination of groups in lieu of a single proposal guaranty to cover the amount bid for the entire proposal. Each proposal guaranty shall identify the groups covered by the individual proposal guaranty. In the event that one proposal guaranty check is intended to cover two or more groups, the amount must be equal to the sum of the proposal guaranties which would be required for each individual group.

The proposal guaranty checks of all, except the two lowest responsible, will be returned promptly after the proposals have been checked, tabulated, and the relation of the proposals established. Proposal guaranty checks of the two lowest bidders will be returned as soon as the contract and contract bond of the successful bidder have been properly executed and approved. If a contract bond is not required, the proposal guaranty check will be held in lieu thereof. Bid bonds will not be returned.

The awarding authority may deny the use of a bid bond as a proposal guaranty but may not further restrict the proposal guaranty. The Notice of Material Letting will state whether a bid bond is allowed.

CHECK SHEET #LRS7

Delivery of Proposals. If a special envelope is supplied by the Awarding Authority, each proposal should be submitted in that envelope furnished by the Awarding Authority and the blank spaces on the envelope shall be filled in correctly to clearly indicate its contents. When an envelope other than the special one furnished by the Awarding Authority is used, it shall be marked to clearly indicate its contents. When sent by mail, the sealed proposal shall be addressed to the Awarding Authority at the address and in care of the official in whose office the bids are to be received. All proposals shall be filed prior to the time and at the place specified in the Notice to Bidders. Proposals received after the time specified will be returned to the bidder unopened.

Withdrawal of Proposals. Permission will be given a bidder to withdraw a proposal if the bidder makes the request in writing or in person before the time for opening proposals.

Public Opening of Proposals. Proposals will be opened and read publicly at the time and place specified in the Notice to Bidders. Bidders, their authorized agents and other interested parties are invited to be present.

Consideration of Proposals. After the proposals are opened and read, they will be compared on the basis of the summation of the products of the quantities shown in the bid schedule by the unit bid prices. In the event of a discrepancy between unit bid prices and extensions, the unit bid price shall govern. In awarding the supply of materials, the Awarding Authority will, in addition to considering the amounts stated in the proposals, take into consideration the responsibility of the various bidders as determined from a study of the data required under "Prequalification of Bidders", and from other investigations which it may elect to make.

The right is reserved to reject any or all proposals, to waive technicalities or to advertise for new proposals, if in the judgment of the Awarding Authority, the best interests of the Awarding Authority will be promoted thereby.

Acceptance of Proposal to Furnish Material. The award will be made within 45 calendar days after the opening of proposals to the lowest responsible and qualified bidder whose proposal complies with all the requirements prescribed. The successful bidder will be notified by letter of intent that his/her bid has been accepted, and subject to the following conditions, the bidder will be the Contractor or Supplier.

An acceptance of proposal to furnish materials executed by the Awarding Authority is required before the Awarding Authority is bound. An award may be cancelled any time by the Awarding Authority prior to execution in order to protect the public interest and integrity of the bidding process or for any other reason if, in the judgment of the Awarding Authority, the best interests of the Awarding Authority will be promoted thereby.

If a material proposal is not awarded within 45 days after the opening of proposals, bidders may file a written request with the Awarding Authority for the withdrawal of their bid, and the Awarding Authority will permit such withdrawal.

Requirement of Contract Bond. If the Awarding Authority requires a Contract Bond, the Contractor or Supplier shall furnish the Awarding Authority a performance and payment bond with good and sufficient sureties in the full amount of the award as

CHECK SHEET #LRS7

the penal sum. The surety shall be acceptable to the Awarding Authority, shall waive notice of any changes and extensions of time, and shall submit its bond on the form furnished by the Awarding Authority.

The contract bond shall be returned within 15 days after the notice of award. Failure of the successful bidder to execute and file acceptable bonds within 15 days after the notice of award has been mailed to the bidder shall be just cause for the cancellation of the award and the forfeiture of the proposal guaranty which shall become the property of the Awarding Authority, not as penalty, but in liquidation of damages sustained. Award may then be made to the next lowest responsible bidder, or the work may be readvertised, or otherwise, as the Awarding Authority may decide.

If the bidder to whom the award is made is a corporation organized under the laws of a State other than Illinois, the bidder shall furnish the Awarding Authority a copy of the corporation's Certificate of Authority to do business in the State of Illinois with the return of the contract bond. Failure to furnish such evidence of a Certificate of Authority within the time required will be considered as just cause for the annulment of the award and the forfeiture of the proposal guaranty to the Awarding Authority, not as a penalty, but in payment of liquidated damages sustained as a result of such failure.

Failure to Execute the Acceptance of Proposal to Furnish Material. If the acceptance of proposal to furnish material is not executed by the Awarding Authority within 15 days following receipt from the bidder of the properly executed bonds, the bidder shall have the right to withdraw his/her bid without penalty.”

De Kalb County Prevailing Wage for July 2015

(See explanation of column headings at bottom of wages)

Trade Name	RG	TYP	C	Base	FRMAN	M-F>8	OSA	OSH	H/W	Pensn	Vac	Trng
=====	==	----	=	=====	=====	=====	----	----	=====	=====	=====	=====
ASBESTOS ABT-GEN		BLD		31.790	32.790	1.5	1.5	2.0	8.420	15.17	0.000	0.800
ASBESTOS ABT-MEC		BLD		36.340	38.840	1.5	1.5	2.0	11.47	10.96	0.000	0.720
BOILERMAKER		BLD		47.070	51.300	2.0	2.0	2.0	6.970	18.13	0.000	0.400
BRICK MASON		BLD		43.780	48.160	1.5	1.5	2.0	10.05	14.43	0.000	1.030
CARPENTER		BLD		39.580	43.930	1.5	1.5	2.0	9.680	15.25	0.000	0.600
CARPENTER		HWY		37.230	38.980	1.5	1.5	2.0	11.00	14.00	0.000	0.490
CEMENT MASON		ALL		43.000	45.000	2.0	1.5	2.0	10.00	18.27	0.000	0.000
CERAMIC TILE FNSHER		BLD		36.810	0.000	1.5	1.5	2.0	10.55	9.230	0.000	0.770
COMMUNICATION TECH		BLD		36.440	40.080	1.5	1.5	2.0	10.39	12.09	0.000	0.760
ELECTRIC PWR EQMT OP		ALL		37.890	51.480	1.5	1.5	2.0	5.000	11.75	0.000	0.380
ELECTRIC PWR EQMT OP		HWY		39.220	53.290	1.5	1.5	2.0	5.000	12.17	0.000	0.390
ELECTRIC PWR GRNDMAN		ALL		29.300	51.480	1.5	1.5	2.0	5.000	9.090	0.000	0.290
ELECTRIC PWR GRNDMAN		HWY		30.330	53.290	1.5	1.5	2.0	5.000	9.400	0.000	0.300
ELECTRIC PWR LINEMAN		ALL		45.360	51.480	1.5	1.5	2.0	5.000	14.06	0.000	0.450
ELECTRIC PWR LINEMAN		HWY		46.950	53.290	1.5	1.5	2.0	5.000	14.56	0.000	0.470
ELECTRIC PWR TRK DRV		ALL		30.340	51.480	1.5	1.5	2.0	5.000	9.400	0.000	0.300
ELECTRIC PWR TRK DRV		HWY		31.400	53.290	1.5	1.5	2.0	5.000	9.730	0.000	0.310
ELECTRICIAN		BLD		42.960	47.260	1.5	1.5	2.0	10.39	17.47	0.000	0.860
ELEVATOR CONSTRUCTOR		BLD		46.830	52.680	2.0	2.0	2.0	13.57	14.51	3.770	0.600
FENCE ERECTOR	SE	ALL		45.060	48.660	2.0	2.0	2.0	10.52	2.760	0.000	0.400
GLAZIER		BLD		35.980	37.980	1.5	1.5	1.5	10.30	8.200	0.000	1.250
HT/FROST INSULATOR		BLD		48.450	50.950	1.5	1.5	2.0	11.47	12.16	0.000	0.720
IRON WORKER	NW	ALL		36.290	38.100	2.0	2.0	2.0	10.24	23.19	0.000	0.500
IRON WORKER	SE	ALL		45.060	48.660	2.0	2.0	2.0	10.52	20.76	0.000	0.700
LABORER		BLD		31.790	32.790	1.5	1.5	2.0	8.420	15.17	0.000	0.800
LABORER		HWY		34.340	35.090	1.5	1.5	2.0	8.420	17.42	0.000	0.800
LABORER, SKILLED		HWY		36.990	37.740	1.5	1.5	2.0	8.420	17.42	0.000	0.800
LATHER		BLD		39.580	43.930	1.5	1.5	2.0	9.680	15.25	0.000	0.600
MACHINIST		BLD		45.350	47.850	1.5	1.5	2.0	7.260	8.950	1.850	0.000
MARBLE MASON		BLD		43.030	47.330	1.5	1.5	2.0	10.05	14.10	0.000	0.780
MATERIAL TESTER I		ALL		33.560	0.000	1.5	1.5	2.0	8.240	16.39	0.000	0.800
MATERIALS TESTER II		ALL		33.560	0.000	1.5	1.5	2.0	8.240	16.39	0.000	0.800
MILLWRIGHT		BLD		36.970	40.670	1.5	1.5	2.0	9.920	14.55	0.000	0.500
OPERATING ENGINEER		BLD 1		43.800	47.800	2.0	2.0	2.0	17.55	11.80	2.350	1.300
OPERATING ENGINEER		BLD 2		43.100	47.800	2.0	2.0	2.0	17.55	11.80	2.350	1.300
OPERATING ENGINEER		BLD 3		40.650	47.800	2.0	2.0	2.0	17.55	11.80	2.350	1.300
OPERATING ENGINEER		BLD 4		38.650	47.800	2.0	2.0	2.0	17.55	11.80	2.350	1.300
OPERATING ENGINEER		BLD 5		47.550	47.800	2.0	2.0	2.0	17.55	11.80	2.350	1.300
OPERATING ENGINEER		BLD 6		46.800	47.800	2.0	2.0	2.0	17.55	11.80	2.350	1.300
OPERATING ENGINEER		BLD 7		43.800	47.800	2.0	2.0	2.0	17.55	11.80	2.350	1.300
OPERATING ENGINEER		HWY 1		43.650	47.650	1.5	1.5	2.0	17.55	11.80	2.350	1.300
OPERATING ENGINEER		HWY 2		43.100	47.650	1.5	1.5	2.0	17.55	11.80	2.350	1.300
OPERATING ENGINEER		HWY 3		41.800	47.650	1.5	1.5	2.0	17.55	11.80	2.350	1.300
OPERATING ENGINEER		HWY 4		40.350	47.650	1.5	1.5	2.0	17.55	11.80	2.350	1.300
OPERATING ENGINEER		HWY 5		38.900	47.650	1.5	1.5	2.0	17.55	11.80	2.350	1.300
OPERATING ENGINEER		HWY 6		46.650	47.650	1.5	1.5	2.0	17.55	11.80	2.350	1.300
OPERATING ENGINEER		HWY 7		44.650	47.650	1.5	1.5	2.0	17.55	11.80	2.350	1.300
ORNAMNTL IRON WORKER	SE	ALL		45.060	48.660	2.0	2.0	2.0	10.52	20.76	0.000	0.700
PAINTER		ALL		41.730	43.730	1.5	1.5	1.5	10.30	8.200	0.000	1.350
PAINTER SIGNS		BLD		33.920	38.090	1.5	1.5	1.5	2.600	2.710	0.000	0.000
PILEDRIVER		BLD		40.080	44.490	1.5	1.5	2.0	9.680	15.25	0.000	0.600
PILEDRIVER		HWY		37.230	38.980	1.5	1.5	2.0	11.00	14.00	0.000	0.490
PIPEFITTER		BLD		46.000	49.000	1.5	1.5	2.0	9.000	15.85	0.000	1.780
PLASTERER		BLD		43.430	46.040	1.5	1.5	2.0	13.05	14.43	0.000	1.020
PLUMBER		BLD		46.650	48.650	1.5	1.5	2.0	13.18	11.46	0.000	0.880
ROOFER		BLD		41.000	44.000	1.5	1.5	2.0	8.280	10.54	0.000	0.530
SHEETMETAL WORKER		BLD		37.930	40.210	1.5	1.5	2.0	6.000	16.92	0.520	0.290
SPRINKLER FTTER		BLD		37.120	39.870	1.5	1.5	2.0	8.420	8.500	0.000	0.350
STEEL ERECTOR	SE	ALL		45.060	48.660	2.0	2.0	2.0	10.52	20.76	0.000	0.700

STONE MASON	BLD	43.780	48.160	1.5	1.5	2.0	10.05	14.43	0.000	1.030		
SURVEY WORKER	-->NOT IN EFFECT	ALL	35.650	36.400	1.5	1.5	2.0	8.240	13.95	0.000	0.800	
TERRAZZO FINISHER	BLD	38.040	0.000	1.5	1.5	2.0	10.55	11.22	0.000	0.720		
TERRAZZO MASON	BLD	41.880	44.880	1.5	1.5	2.0	10.55	12.51	0.000	0.940		
TILE LAYER	BLD	39.580	43.930	1.5	1.5	2.0	9.680	15.25	0.000	0.600		
TILE MASON	BLD	43.840	47.840	1.5	1.5	2.0	10.55	11.40	0.000	0.990		
TRUCK DRIVER	ALL 1	35.600	35.800	1.5	1.5	1.5	8.250	9.140	0.000	0.150		
TRUCK DRIVER	ALL 2	32.700	33.100	1.5	1.5	2.0	6.500	4.350	0.000	0.000		
TRUCK DRIVER	ALL 3	32.900	33.100	1.5	1.5	2.0	6.500	4.350	0.000	0.000		
TRUCK DRIVER	ALL 4	33.100	33.100	1.5	1.5	2.0	6.500	4.350	0.000	0.000		
TUCKPOINTER	BLD	43.800	44.800	1.5	1.5	2.0	8.280	13.49	0.000	0.670		

Legend: RG (Region)

TYP (Trade Type - All,Highway,Building,Floating,Oil & Chip,Rivers)

C (Class)

Base (Base Wage Rate)

FRMAN (Foreman Rate)

M-F>8 (OT required for any hour greater than 8 worked each day, Mon through Fri.)

OSA (Overtime (OT) is required for every hour worked on Saturday)

OSH (Overtime is required for every hour worked on Sunday and Holidays)

H/W (Health & Welfare Insurance)

Pensn (Pension)

Vac (Vacation)

Trng (Training)

Explanations**DEKALB COUNTY**

IRONWORKERS (NORTHWEST) - That portion of the county from a point where the western county line intersects with Rt. 30, continuing eastward to Shabbona, north between Shabbona and Clare, and northeast between Clare and New Lebanon.

The following list is considered as those days for which holiday rates of wages for work performed apply: New Years Day, Memorial Day, Fourth of July, Labor Day, Thanksgiving Day, Christmas Day and Veterans Day in some classifications/counties. Generally, any of these holidays which fall on a Sunday is celebrated on the following Monday. This then makes work performed on that Monday payable at the appropriate overtime rate for holiday pay. Common practice in a given local may alter certain days of celebration. If in doubt, please check with IDOL.

EXPLANATION OF CLASSES

ASBESTOS - GENERAL - removal of asbestos material/mold and hazardous materials from any place in a building, including mechanical systems where those mechanical systems are to be removed. This includes the removal of asbestos materials/mold and hazardous materials from ductwork or pipes in a building when the building is to be demolished at the time or at some close future date.

ASBESTOS - MECHANICAL - removal of asbestos material from mechanical systems, such as pipes, ducts, and boilers, where the mechanical systems are to remain.

CERAMIC TILE FINISHER

The grouting, cleaning, and polishing of all classes of tile, whether for interior or exterior purposes, all burned, glazed or unglazed products; all composition materials, granite tiles, warning detectable tiles, cement tiles, epoxy composite materials, pavers, glass, mosaics, fiberglass, and all substitute materials, for tile made in tile-like units; all mixtures in tile like form of cement, metals, and other materials that are for and intended for use as a finished floor surface, stair treads, promenade roofs, walks, walls, ceilings, swimming pools, and all other places where tile is to form a finished

interior or exterior. The mixing of all setting mortars including but not limited to thin-set mortars, epoxies, wall mud, and any other sand and cement mixtures or adhesives when used in the preparation, installation, repair, or maintenance of tile and/or similar materials. The handling and unloading of all sand, cement, lime, tile, fixtures, equipment, adhesives, or any other materials to be used in the preparation, installation, repair, or maintenance of tile and/or similar materials. Ceramic Tile Finishers shall fill all joints and voids regardless of method on all tile work, particularly and especially after installation of said tile work. Application of any and all protective coverings to all types of tile installations including, but not be limited to, all soap compounds, paper products, tapes, and all polyethylene coverings, plywood, masonite, cardboard, and any new type of products that may be used to protect tile installations, Blastrac equipment, and all floor scarifying equipment used in preparing floors to receive tile. The clean up and removal of all waste and materials. All demolition of existing tile floors and walls to be re-tiled.

COMMUNICATIONS TECHNICIAN

Installing, manufacturing, assembling and maintaining sound and intercom, protection alarm (security), fire alarm, master antenna television, closed circuit television, low voltage control for computers and/or door monitoring, school communications systems, telephones and servicing of nurse and emergency calls, and the installation and maintenance of transmit and receive antennas, transmitters, receivers, and associated apparatus which operates in conjunction with above systems. All work associated with these system installations will be included EXCEPT the installation of protective metallic conduit in new construction projects (excluding less than ten-foot, runs strictly for protection of cable) and 120 volt AC (or higher) power wiring and associated hardware.

LABORER, SKILLED - HIGHWAY

Individuals engaged in the following types of work, irrespective of the site of the work: asbestos abatement worker, handling of any materials with any foreign matter harmful to skin or clothing, track laborer, cement handlers, chloride handlers, the unloading and loading with steel workers and re-bars, concrete workers wet, tunnel helpers in free air, batch dumpers, mason tenders, kettle and tar men, tank cleaners, plastic installers, scaffold workers, motorized buggies or motorized unit used for wet concrete or handling of building materials, laborers with de-watering systems, sewer workers plus depth, rod and chainmen with technical engineers, rod and chainmen with land surveyors, rod and chainmen with surveyors, vibrator operators, cement silica, clay, fly ash, lime and plasters, handlers (bulk or bag), cofferdam workers plus depth, on concrete paving, placing, cutting and tying of reinforcing, deck hand, dredge hand, and shore laborers, bankmen on floating plant, grade checker, power tools, front end man on chip spreaders, cession workers plus depth, gunnite nozzle men, lead man on sewer work, welders, cutters, burners and torchmen, chainsaw operators, jackhammer and drill operators, layout man and/or drainage tile layer, steel form setter - street and highway, air tamping hammermen, signal man on crane, concrete saw operator, screedman on asphalt pavers, laborers tending masons with hot material or where foreign materials are used, mortar mixer operators, multiple concrete duct - leadsman, lumen, asphalt raker, curb asphalt machine operator, ready mix scalemen (permanent, portable or temporary plant), laborers handling masterplate or similar materials, laser beam operator, concrete burning machine operator, coring machine operator, plaster tender, underpinning and shoring of buildings, pump men, manhole and catch basin, dirt and stone tamper, hose men on concrete pumps, hazardous waste worker, lead base paint abatement worker, lining of pipe, refusing machine, assisting on direct boring machine, the work of laying watermain, fire hydrants,

all mechanical joints to watermain work, sewer worker, and tapping water service and forced lift station mechanical worker.

MATERIAL TESTER I: Hand coring and drilling for testing of materials; field inspection of uncured concrete and asphalt.

MATERIAL TESTER II: Field inspection of welds, structural steel, fireproofing, masonry, soil, facade, reinforcing steel, formwork, cured concrete, and concrete and asphalt batch plants; adjusting proportions of bituminous mixtures.

OPERATING ENGINEERS - BUILDING

Class 1. Asphalt Plant; Asphalt Spreader; Autograde; Backhoes with Caisson Attachment; Batch Plant; Benoto (requires Two Engineers); Boiler and Throttle Valve; Caisson Rigs; Central Redi-Mix Plant; Combination Back Hoe Front End-loader Machine; Compressor and Throttle Valve; Concrete Breaker (Truck Mounted); Concrete Conveyor; Concrete Paver (over 27E cu. ft.): Concrete Paver (27 cu. ft. and under); Concrete Placer; Concrete Pump (Truck Mounted); Concrete Conveyor (Truck Mounted); Concrete Tower; Cranes, All; GCI and similar types (required two operators only); Cranes, Hammerhead; Creter Crane; Crusher, Stone, etc.; Derricks, All; Derricks, Traveling; Formless Curb and Gutter Machine; Grader, Elevating; Grouting Machines; Highlift Shovels or Front Endloader 2-1/4 yd. and over; Hoists, Elevators, outside type rack and pinion and similar machines; Hoists, one, two and three Drum; Hoists, Two Tugger One Floor; Hydraulic Backhoes; Hydraulic Boom Trucks; Hydro Vac (and similar equipment - excluding hose work and any sewer work); Locomotives, All; Lubrication Technician; Manipulators; Motor Patrol; Pile Drivers and Skid Rig; Post Hole Digger; Pre-Stress Machine; Pump Cretes Dual Ram; Pump Cretes; Squeeze Cretes - Screw Type Pumps, Gypsum Bulker and Pump; Raised and Blind Hole Drill; Rock Drill (self-propelled); Rock Drill - Truck Mounted; Roto Mill Grinder; Scoops - Tractor Drawn; Slipform Paver; Scrapers Prime Movers; Straddle Buggies; Tie Back Machine; Tractor with Boom and Side Boom; Trenching Machines.

Class 2. Bobcat (over 3/4 cu. yd.); Boilers; Brick Forklift; Broom, All Power Propelled; Bulldozers; Concrete Mixer (Two Bag and Over); Conveyor, Portable; Forklift Trucks; Highlift Shovels or Front Endloaders under 2-1/4 yd.; Hoists, Automatic; Hoists, Sewer Dragging Machine; Hoists, Tugger Single Drum; Laser Screed; Rollers, All; Steam Generators; Tractors, All; Tractor Drawn Vibratory Roller; Winch Trucks with "A" Frame.

Class 3. Air Compressor; Asphalt Spreader; Combination - Small Equipment Operator; Generators; Heaters, Mechanical; Hoists, Inside Elevators - (Rheostat Manual Controlled); Hydraulic Power Units (Pile Driving, Extracting, or Drilling - with a seat); Lowboys; Pumps, Over 3" (1 to 3 not to exceed total of 300 ft.); Pumps, Well Points; Welding Machines (2 through 5); Winches, 4 Small Electric Drill Winches; Bobcat (up to and including 3/4 cu. yd.).

Class 4. Elevator push button with automatic doors; Hoists, Inside; Oilers; Brick Forklift.

Class 5. Assistant Craft Foreman

Class 6. Mechanics; Welders.

Class 7. Gradall

OPERATING ENGINEERS - HIGHWAY CONSTRUCTION

Class 1. Asphalt Plant; Asphalt Heater and Planer Combination; Asphalt Heater Scarfire; Asphalt Silo Tender; Asphalt Spreader; Autograder;

ABG Paver; Backhoes with Caisson Attachment; Ballast Regulator; Belt Loader; Caisson Rigs; Car Dumper; Central Redi-Mix Plant; Backhoe w/shear attachments; Combination Backhoe Front Endloader Machine, (1 cu. yd. Backhoe Bucket or over or with attachments); Concrete Breaker (Truck Mounted); Concrete Conveyor; Concrete Paver over 27E cu. ft.; Concrete Placer; Concrete Tube Float; Cranes, all attachments; Cranes, Tower of all types; Creter Crane; Crusher, Stone, etc.; Derricks, All; Derrick Boats; Derricks, Traveling; Directional Boring Machine over 12"; Dredges; Formless Curb and Gutter Machine; Grader, Elevating; Grader, Motor Grader, Motor Patrol, Auto Patrol, Form Grader, Pull Grader, Subgrader; Guard Rail Post Driver Mounted; Hoists, One, Two and Three Drum; Hydraulic Backhoes; Hydro Vac, Self Propelled, Truck Mounted (excluding hose work and any sewer work); Lubrication Technician; Manipulators; Pile Drivers and Skid Rig; Pre-Stress Machine; Pump Cretes Dual Ram; Rock Drill - Crawler or Skid Rig; Rock Drill - Truck Mounted; Rock/Track Tamper; Roto Mill Grinder; Slip-Form Paver; Snow Melters; Soil Test Drill Rig (Truck Mounted); Straddle Buggies; GCI Crane; Hydraulic Telescoping Form (Tunnel); Tie Back Machine; Tractor Drawn Belt Loader; Tractor Drawn Belt Loader with attached pusher; Tractor with Boom; Tractaire with Attachments; Traffic Barrier Conveyor Machine; Raised or Blind Hole Drills; Trenching Machine (over 12"); Truck Mounted Concrete Pump with Boom; Truck Mounted Concrete Conveyor; Work Boat (no license required - 90 h.p. or above); Underground Boring and/or Mining Machines; Wheel Excavator; Widener (APSCO).

Class 2. Batch Plant; Bituminous Mixer; Boiler and Throttle Valve; Bulldozers; Car Loader Trailing Conveyors; Combination Backhoe Front Endloader Machine (less than 1 cu. yd. Backhoe Bucket or over or with attachments); Compressor and Throttle Valve; Compressor, Common Receiver (3); Concrete Breaker or Hydro Hammer; Concrete Grinding Machine; Concrete Mixer or Paver 7S Series to and including 27 cu. ft.; Concrete Spreader; Concrete Curing Machine, Burlap Machine, Belting Machine and Sealing Machine; Concrete Wheel Saw (large self-propelled - excluding walk-behinds and hand-held); Conveyor Muck Cars (Haglund or Similar Type); Drills, all; Finishing Machine - Concrete; Highlift Shovels or Front Endloader; Hoist - Sewer Dragging Machine; Hydraulic Boom Trucks (All Attachments); Hydro Blaster; All Locomotives, Dinky; Off-Road Hauling Units; Non-Self Loading Dump; Ejection Dump; Pump Cretes: Squeeze Cretes - Screw Type Pumps, Gypsum Bulker and Pump; Roller, Asphalt; Rotary Snow Plows; Rototiller, Seaman, etc., self-propelled; Scoops - Tractor Drawn; Self-Propelled Compactor; Spreader - Chip - Stone, etc.; Scraper; Scraper - Prime Mover in Tandem (Regardless of Size); Tank Car Heater; Tractors, Push, Pulling Sheeps Foot, Disc, Compactor, etc.; Tug Boats.

Class 3. Boilers; Brooms, All Power Propelled; Cement Supply Tender; Compressor, Common Receiver (2); Concrete Mixer (Two Bag and Over); Conveyor, Portable; Farm-Type Tractors Used for Mowing, Seeding, etc.; Fireman on Boilers; Forklift Trucks; Grouting Machine; Hoists, Automatic; Hoists, All Elevators; Hoists, Tugger Single Drum; Jeep Diggers; Low Boys; Pipe Jacking Machines; Post-Hole Digger; Power Saw, Concrete Power Driven; Pug Mills; Rollers, other than asphalt; Seed and Straw Blower; Steam Generators; Stump Machine; Winch Trucks with "A" Frame; Work Boats; Tamper - Form - Motor Driven.

Class 4. Air Compressor - Small and Large; Asphalt Spreader, Backend Man; Bobcat (Skid Steer) all; Brick Forklift; Combination - Small Equipment Operator; Directional Boring Machine up to 12"; Generators; Heaters, Mechanical; Hydraulic Power Unit (Pile Driving, Extracting, or Drilling); Hydro-Blaster; Light Plants, All (1 through 5); Pumps, over 3" (1 to 3 not to exceed a total of 300 ft.); Pumps, Well Points; Tractaire; Trencher 12" and under; Welding Machines (2 through 5); Winches, 4 Small Electric Drill Winches.

Class 5. Oilers and Directional Boring Machine Locator.

Class 6. Field Mechanics and Field Welders

Class 7. Gradall and machines of like nature.

SURVEY WORKER - Operated survey equipment including data collectors, G.P.S. and robotic instruments, as well as conventional levels and transits.

TERRAZZO FINISHER

The handling of sand, cement, marble chips, and all other materials that may be used by the Mosaic Terrazzo Mechanic, and the mixing, grinding, grouting, cleaning and sealing of all Marble, Mosaic, and Terrazzo work, floors, base, stairs, and wainscoting by hand or machine, and in addition, assisting and aiding Marble, Masonic, and Terrazzo Mechanics.

TRUCK DRIVER - BUILDING, HEAVY AND HIGHWAY CONSTRUCTION

Class 1. Two or three Axle Trucks. A-frame Truck when used for transportation purposes; Air Compressors and Welding Machines, including those pulled by cars, pick-up trucks and tractors; Ambulances; Batch Gate Lockers; Batch Hopperman; Car and Truck Washers; Carry-alls; Fork Lifts and Hoisters; Helpers; Mechanics Helpers and Greasers; Oil Distributors 2-man operation; Pavement Breakers; Pole Trailer, up to 40 feet; Power Mower Tractors; Self-propelled Chip Spreader; Skipman; Slurry Trucks, 2-man operation; Slurry Truck Conveyor Operation, 2 or 3 man; Teamsters Unskilled dumpman; and Truck Drivers hauling warning lights, barricades, and portable toilets on the job site.

Class 2. Four axle trucks; Dump Crets and Adgetors under 7 yards; Dumpsters, Track Trucks, Euclids, Hug Bottom Dump Turnapulls or Turnatrailers when pulling other than self-loading equipment or similar equipment under 16 cubic yards; Mixer Trucks under 7 yards; Ready-mix Plant Hopper Operator, and Winch Trucks, 2 Axles.

Class 3. Five axle trucks; Dump Crets and Adgetors 7 yards and over; Dumpsters, Track Trucks, Euclids, Hug Bottom Dump Turnatrailers or turnapulls when pulling other than self-loading equipment or similar equipment over 16 cubic yards; Explosives and/or Fission Material Trucks; Mixer Trucks 7 yards or over; Mobile Cranes while in transit; Oil Distributors, 1-man operation; Pole Trailer, over 40 feet; Pole and Expandable Trailers hauling material over 50 feet long; Slurry trucks, 1-man operation; Winch trucks, 3 axles or more; Mechanic--Truck Welder and Truck Painter.

Class 4. Six axle trucks; Dual-purpose vehicles, such as mounted crane trucks with hoist and accessories; Foreman; Master Mechanic; Self-loading equipment like P.B. and trucks with scoops on the front.

Other Classifications of Work:

For definitions of classifications not otherwise set out, the Department generally has on file such definitions which are available. If a task to be performed is not subject to one of the classifications of pay set out, the Department will upon being contacted state which neighboring county has such a classification and provide such rate, such rate being deemed to exist by reference in this document. If no neighboring county rate applies to the task, the Department shall undertake a special determination, such special determination being then deemed to have existed under this determination. If a project requires these, or any classification not listed, please contact IDOL at 217-782-1710 for wage rates or clarifications.

LANDSCAPING

Landscaping work falls under the existing classifications for laborer, operating engineer and truck driver. The work performed by landscape plantsman and landscape laborer is covered by the existing classification of laborer. The work performed by landscape operators (regardless of equipment used or its size) is covered by the classifications of operating engineer. The work performed by landscape truck drivers (regardless of size of truck driven) is covered by the classifications of truck driver.

SQUAW GROVE TWP.

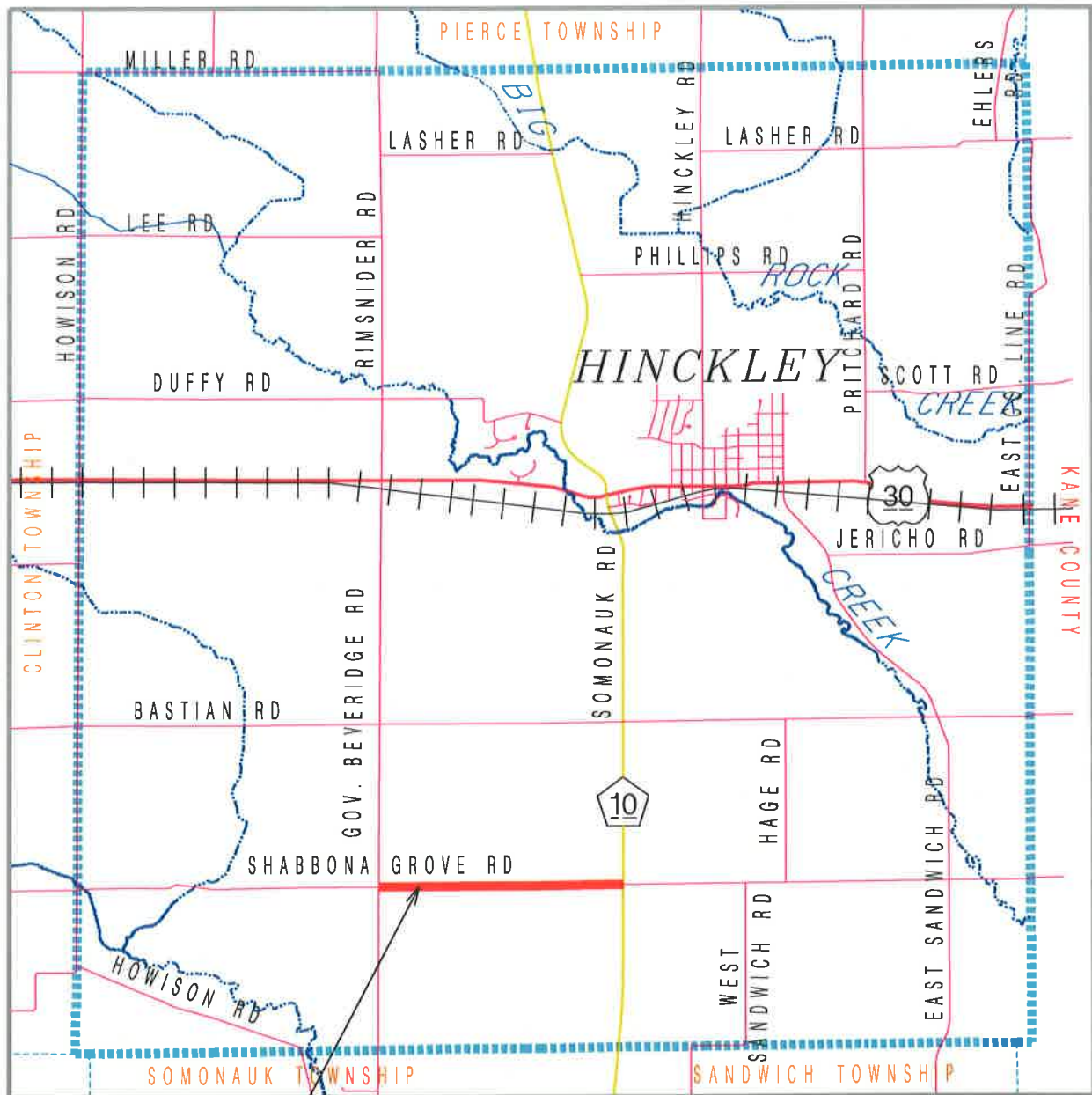
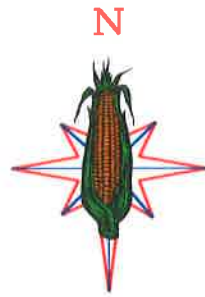

SECTION 17-17000-00-GM
SQUAW GROVE ROAD DISTRICT
LOCATION OF PROPOSED AGGREGATE S.O.R.

VICTOR TWP.

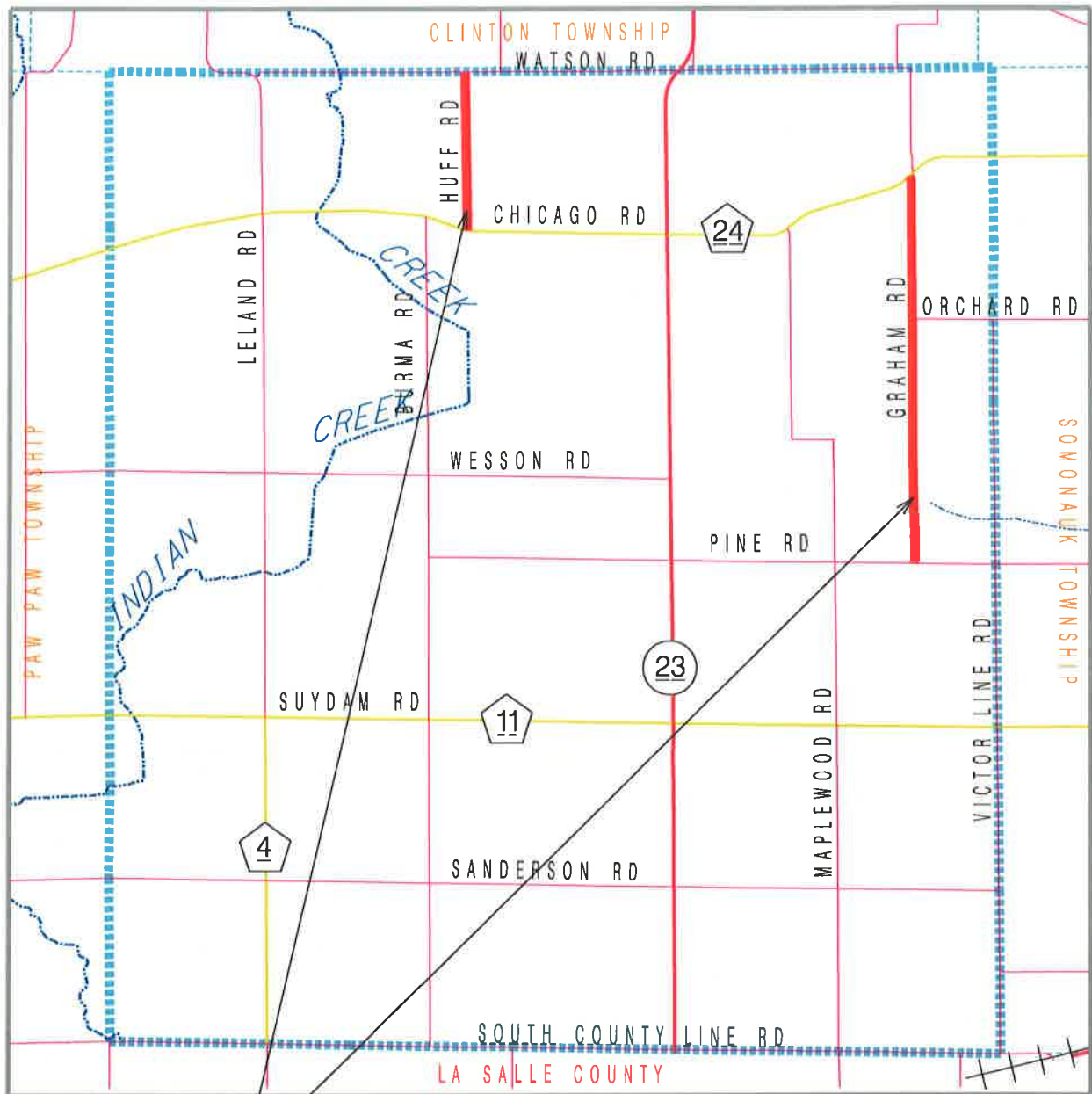
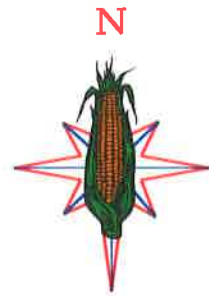

SECTION 17-19000-00-GM
VICTOR ROAD DISTRICT
LOCATION OF PROPOSED AGGREGATE S.O.R.

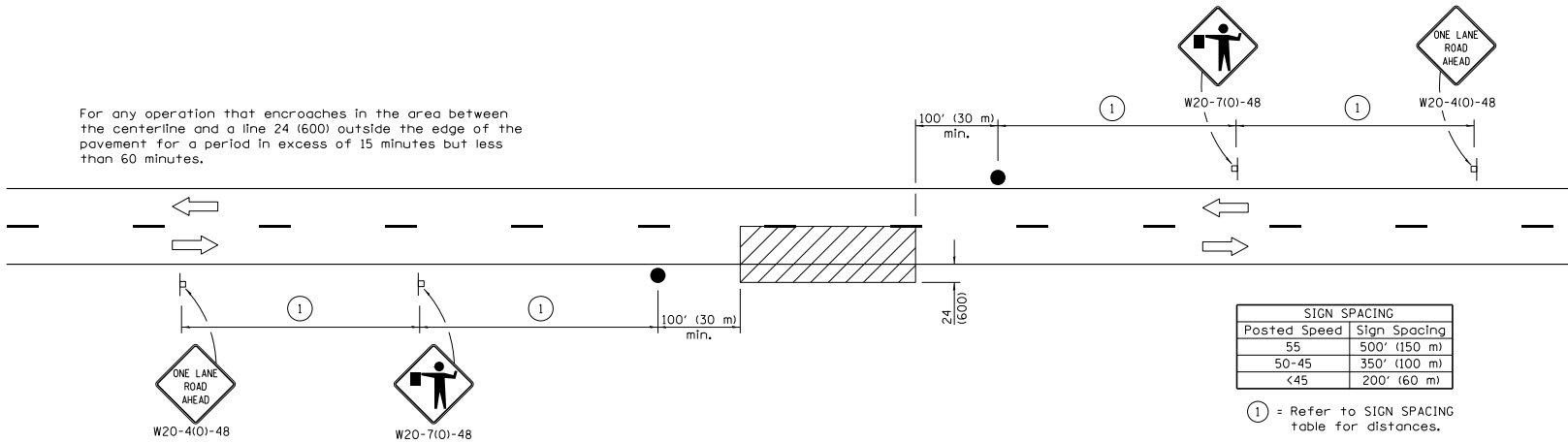
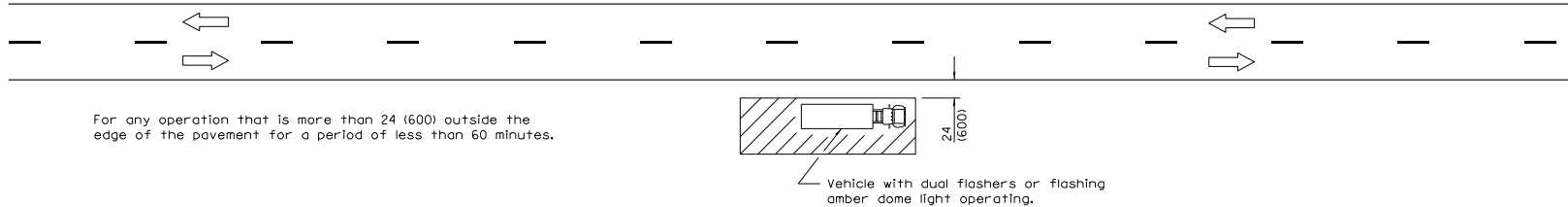
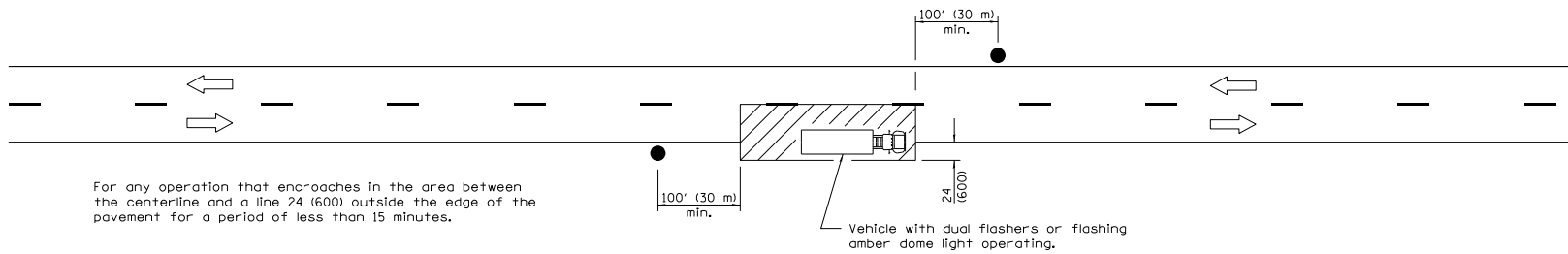

SIGN SPACING	
Posted Speed	Sign Spacing
55	500' (150 m)
50-45	350' (100 m)
<45	200' (60 m)

TYPICAL APPLICATIONS

- Marking patches
- Field survey
- String line
- Utility operations
- Cleaning up debris on pavement

SYMBOLS

- Work area
- Sign on portable or permanent support
- Flagger with traffic control sign

All dimensions are in inches (millimeters) unless otherwise shown.

Illinois Department of Transportation

ISSUED 1-1-11

APPROVED January 1, 2011
 ENGINEER OF SAFETY ENGINEERING

APPROVED January 1, 2011
 ENGINEER OF DESIGN AND ENVIRONMENT

DATE	REVISIONS
1-1-11	Revised flagger sign.
1-1-09	Switched units to English (metric).

LANE CLOSURE, 2L, 2W, SHORT TIME OPERATIONS

STANDARD 701301-04

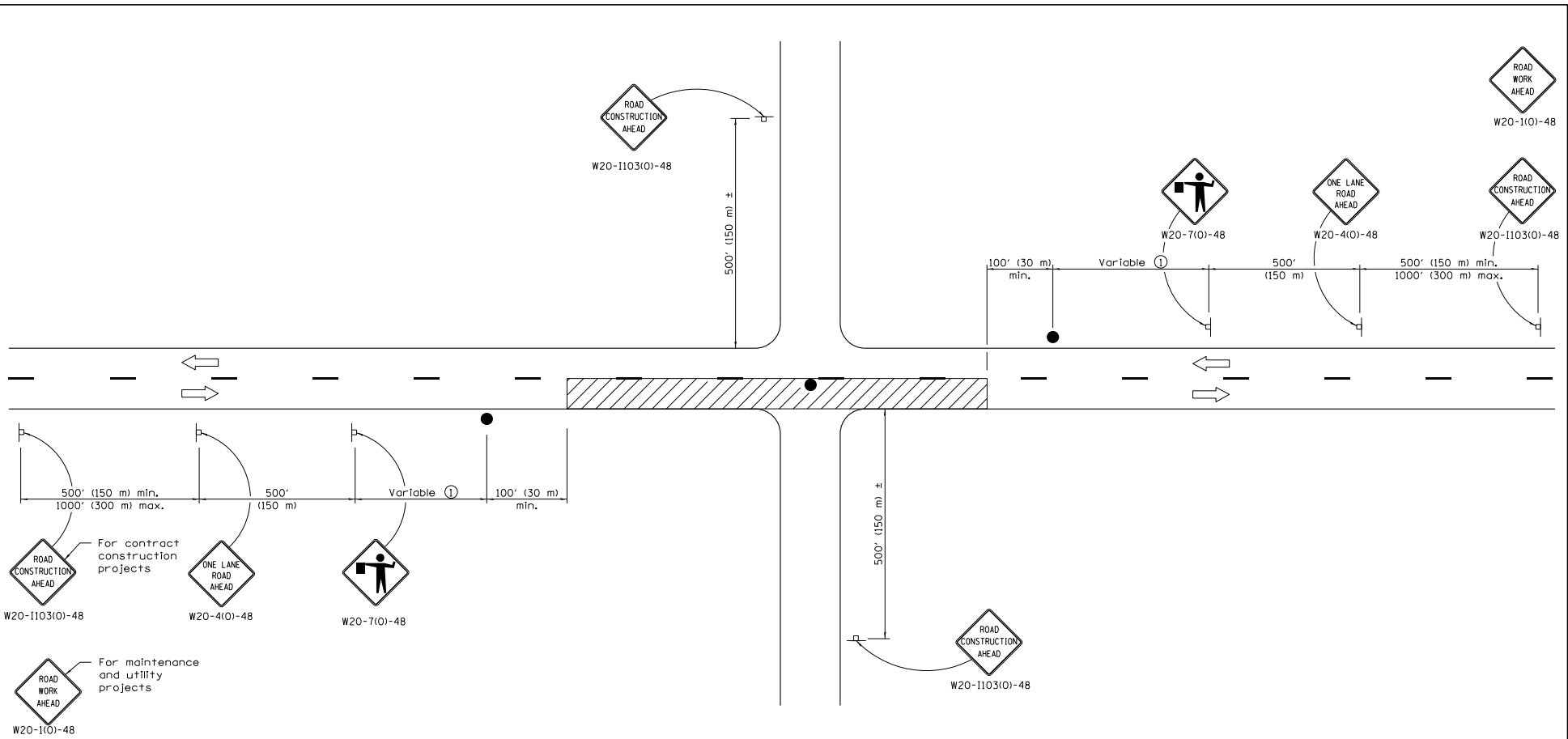

For contract construction projects

W20-1103(O)-48

W20-4(O)-48

W20-7(O)-48

For maintenance and utility projects

W20-1103(O)-48

TYPICAL APPLICATIONS

- Bituminous resurfacing
- Milling operations
- Utility operations
- Shoulder operations

SYMBOLS

- Work area
- Sign on portable or permanent support
- Flagger with traffic control sign

① Minimum distance is 200' (60 m). Maximum distance to be determined by the Engineer but should not exceed 1/2 the length required for one normal working day's operation or 2 miles (3200 m), whichever is less.

GENERAL NOTES

This Standard is used where at any time, any vehicle, equipment, workers or their activities require an intermittent or continuous moving operation on the pavement where the average speed of movement is greater than 1 mph (2 km/h) and less than 4 mph (6 km/h).

When the operation does not exceed 60 minutes, traffic control may be according to Standard 701301.

All dimensions are in inches (millimeters) unless otherwise shown.

DATE	REVISIONS
1-1-11	Revised flagger sign.
1-1-09	Switched units to English (metric).
	Corrected sign No.'s.

LANE CLOSURE, 2L, 2W, SLOW MOVING OPERATIONS DAY ONLY, FOR SPEEDS ≥ 45 MPH

STANDARD 701306-03

Illinois Department of Transportation

APPROVED January 1, 2011
 ENGINEER OF SAFETY ENGINEERING

APPROVED January 1, 2011
 ENGINEER OF DESIGN AND ENVIRONMENT

ISSUED 1-1-11

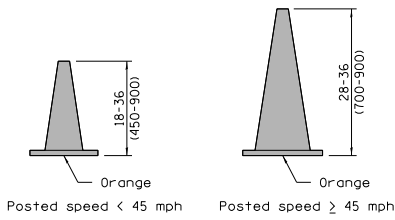

CONE FOR DAYTIME

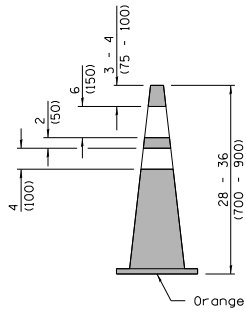

REFLECTORIZED CONE FOR NIGHTTIME

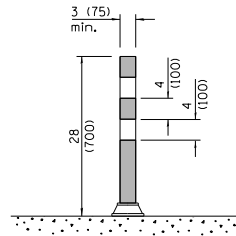

TUBULAR MARKER

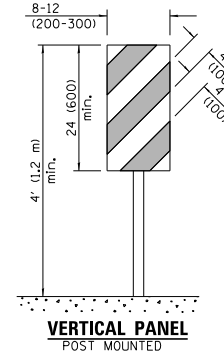

VERTICAL PANEL POST MOUNTED

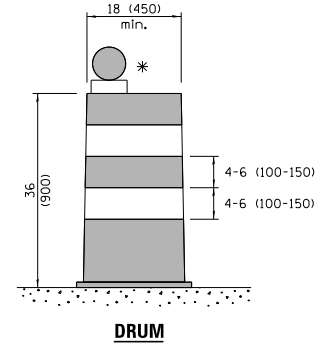

DRUM

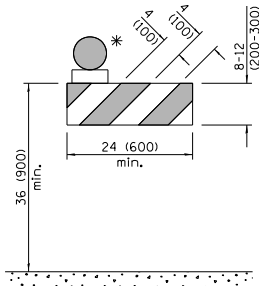

TYPE I BARRICADE

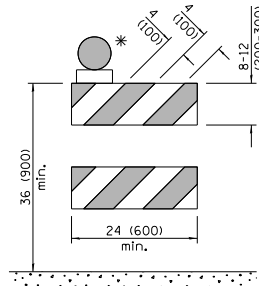

TYPE II BARRICADE

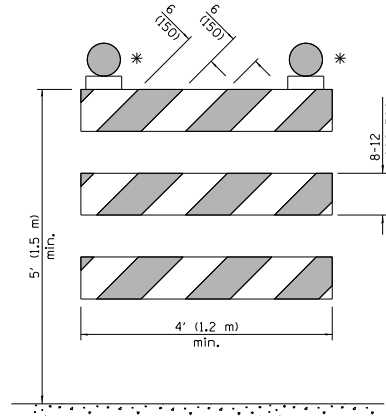

TYPE III BARRICADE

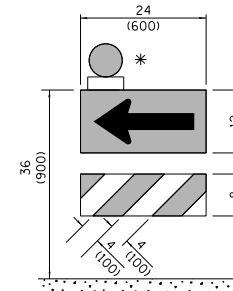

DIRECTION INDICATOR BARRICADE

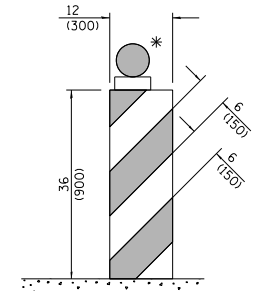

VERTICAL BARRICADE

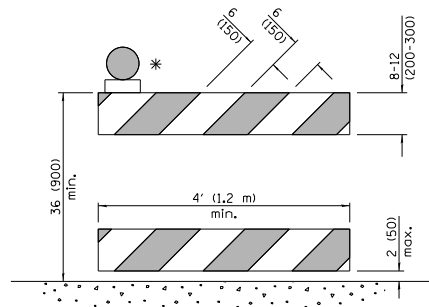

DETECTABLE PEDESTRIAN CHANNELIZING BARRICADE

* Warning lights (if required)

GENERAL NOTES

All heights shown shall be measured above the pavement surface.

All dimensions are in inches (millimeters) unless otherwise shown.

DATE	REVISIONS
1-1-17	Changed FLEXIBLE DELINEATOR to TUBULAR MARKER.
4-1-16	Add dim's to barricades. Rev. note for post mnt. signs.
	Rev. cone dtls. Add W12-1103.

TRAFFIC CONTROL DEVICES

(Sheet 1 of 3)

STANDARD 701901-06

Illinois Department of Transportation

APPROVED January 1, 2017
Jim Allen
 ENGINEER OF OPERATIONS

APPROVED January 1, 2017
Maureen M. Biele
 ENGINEER OF DESIGN AND ENVIRONMENT

ISSUED 46-1-1

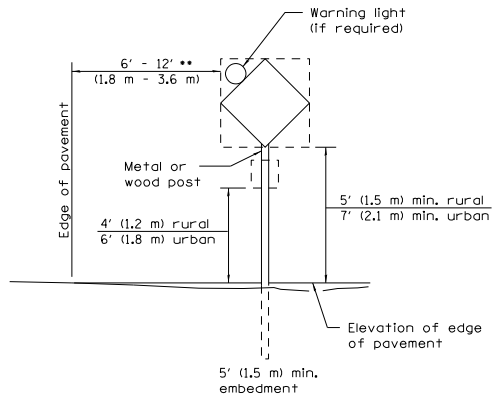

POST MOUNTED SIGNS

** When curb or paved shoulder are present this dimension shall be 24 (600) to the face of curb or 6' (1.8 m) to the outside edge of the paved shoulder.

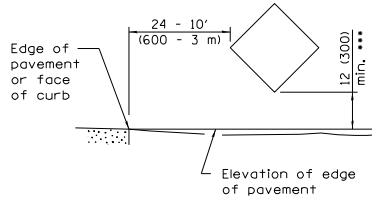

SIGNS ON TEMPORARY SUPPORTS

*** When work operations exceed four days, this dimension shall be 5' (1.5 m) min. If located behind other devices, the height shall be sufficient to be seen completely above the devices.

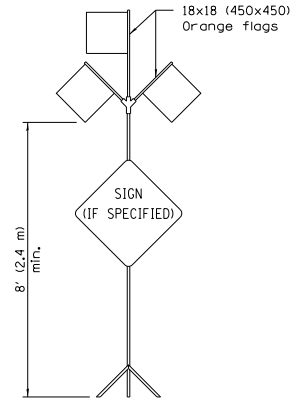

HIGH LEVEL WARNING DEVICE

ROAD
CONSTRUCTION
NEXT X MILES

END
CONSTRUCTION

G20-1104(O)-6036

G20-1105(O)-6024

This signing is required for all projects 2 miles (3200 m) or more in length.

ROAD CONSTRUCTION NEXT X MILES sign shall be placed 500' (150 m) in advance of project limits.

END CONSTRUCTION sign shall be erected at the end of the job unless another job is within 2 miles (3200 m).

Dual sign displays shall be utilized on multi-lane highways.

WORK LIMIT SIGNING

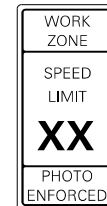

W21-1115(O)-3618

R2-1-3648

R10-1108p-3618 ****



R2-1106p-3618

Sign assembly as shown on Standards or as allowed by District Operations.

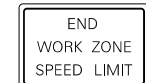

G20-1103(O)-6036

This sign shall be used when the above sign assembly is used.

**HIGHWAY CONSTRUCTION
SPEED ZONE SIGNS**

**** R10-1108p shall only be used along roadways under the jurisdiction of the State.

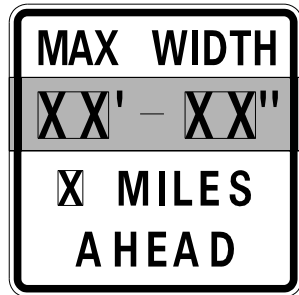

W12-1103-4848

WIDTH RESTRICTION SIGN

XX'-XX" width and X miles are variable.

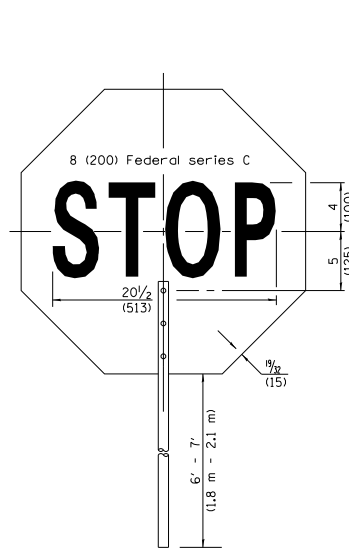

FRONT SIDE

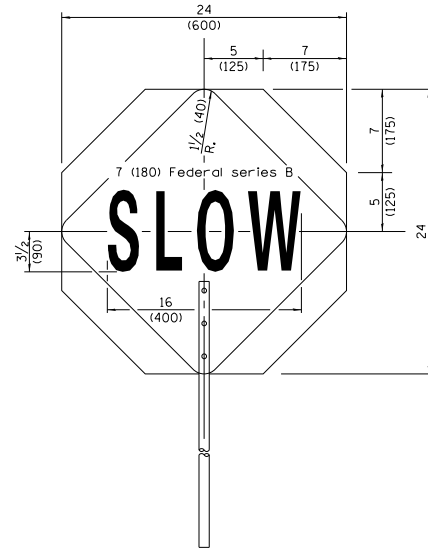

REVERSE SIDE

FLAGGER TRAFFIC CONTROL SIGN

Illinois Department of Transportation

APPROVED January 1, 2017
Jan Allen
 ENGINEER OF OPERATIONS

ISSUED 1-1-97

APPROVED January 1, 2017
Maureen M. Biele
 ENGINEER OF DESIGN AND ENVIRONMENT

**TRAFFIC CONTROL
DEVICES**

(Sheet 2 of 3)

STANDARD 701901-06

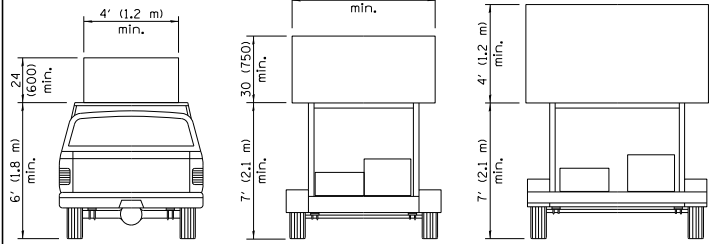

**TYPE A
ROOF
MOUNTED**

**TYPE B
ROOF OR TRAILER
MOUNTED**

**TYPE C
TRAILER
MOUNTED**

ARROW BOARDS

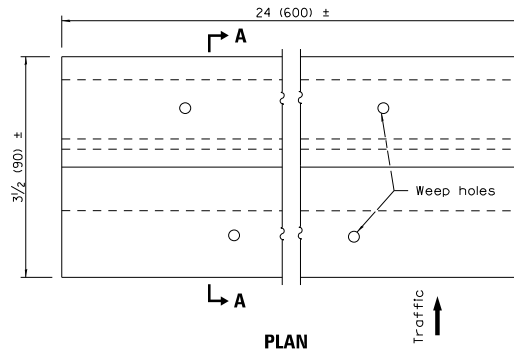

PLAN

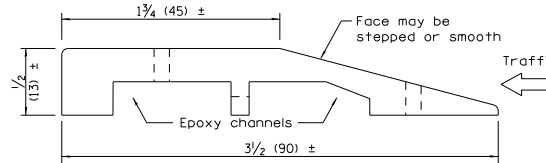

SECTION A-A

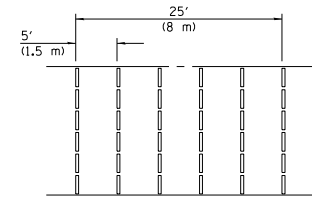
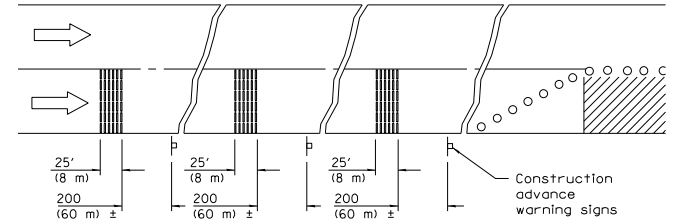

TYPICAL INSTALLATION

TEMPORARY RUMBLE STRIPS

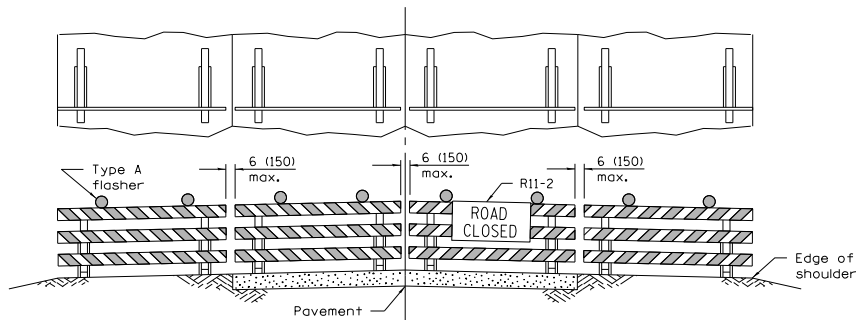

ROAD CLOSED TO ALL TRAFFIC

Reflectorized striping may be omitted on the back side of the barricades. If a Type III barricade with an attached sign panel which meets NCHRP 350 is not available, the sign may be mounted on an NCHRP 350 temporary sign support directly in front of the barricade.

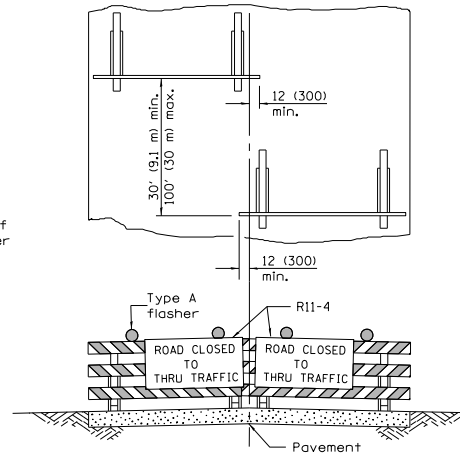

ROAD CLOSED TO THRU TRAFFIC

Reflectorized striping shall appear on both sides of the barricades. If a Type III barricade with an attached sign panel which meets NCHRP 350 is not available, the signs may be mounted on NCHRP 350 temporary sign supports directly in front of the barricade.

**TYPICAL APPLICATIONS OF
TYPE III BARRICADES CLOSING A ROAD**

**TRAFFIC CONTROL
DEVICES**

(Sheet 3 of 3)

STANDARD 701901-06

Illinois Department of Transportation

APPROVED January 1, 2017
Jim Allen
 ENGINEER OF OPERATIONS

APPROVED January 1, 2017
Maureen M. Bales
 ENGINEER OF DESIGN AND ENVIRONMENT

ISSUED 1-1-97