



Illinois Department of Transportation

**Local Public Agency
Material Proposal or
Deliver & Install Proposal**

PROPOSAL SUBMITTED BY		
Contractor's Name		
Street	P.O. Box	
City	State	Zip Code

STATE OF ILLINOIS

COUNTY OF DeKalb
DeKalb County Highway Department
 (Name of City, Village, Town or Road District)

FOR THE IMPROVEMENT OF

STREET NAME OR ROUTE NO. Various
 SECTION NO. 2015 Rejuvenator
 TYPES OF FUNDS Local

- MATERIAL PROPOSAL DELIVER & INSTALL PROPOSAL
 SPECIFICATIONS (required) PLANS (if applicable)

For Municipal Projects
 Submitted/Approved/Passed

Mayor President of Board of Trustees Municipal Official

Date

Department of Transportation

Released for bid based on limited review

Regional Engineer

Date

For County and Road District Projects
 Submitted/Approved

Highway Commissioner

Date

Submitted/Approved

County Engineer/Superintendent of Highways

Date

Note: All proposal documents, including Proposal Guaranty Checks or Proposal Bid Bonds, should be stapled together to prevent loss when bids are processed.

RETURN WITH BID

NOTICE TO BIDDERS

County DeKalb
Local Public Agency DeKalb Highway Dept
Section Number 2015 Rejuvenator
Route Various

Sealed proposals for the furnishing or delivering & installing materials required in the construction/maintenance of the above Section will be received and at that time publicly opened and read at the office of the DeKalb County Engineer,

1826 Barber Greene Road, DeKalb, IL 60115 until 10:00 AM on April 2, 2015
Address Time Date

- 1. Plans and proposal forms will be available in the office of the DeKalb County Engineer 1826 Barber Greene Road, DeKalb, IL 60115
2. Prequalification. If checked, the 2 low bidders must file within 24 hours after the letting an "Affidavit of Availability" (Form BC 57), in duplicate, showing all uncompleted contracts awarded to them and all low bids pending award for Federal, State, County, Municipal and private work.
3. The Awarding Authority reserves the right to waive technicalities and to reject any or all proposals as provided in BLRS Special Provision for Bidding Requirements and Conditions for Material Proposals.
4. A proposal guaranty in the proper amount, as specified in BLRS Special Provision for Bidding Requirements and Conditions for Material Proposals, will be required. Bid Bonds will not be allowed as a proposal guaranty.
5. The successful bidder at the time of execution of the contract will not be required to deposit a contract bond for the full amount of the award. When a contract bond is not required, the proposal guaranty check will be held in lieu thereof. Failure on the part of the contractor to deliver the material within the time specified or to do the work specified herein will be considered just cause to forfeit his surety as provided in Article 108.10 of the Standard Specifications.
6. Proposals shall be submitted on forms furnished by the Awarding Authority and shall be enclosed in an envelope endorsed "Material Proposal, Section 2015 Rejuvenator".

By Order of DeKalb County Board 02/20/2015 Nathan F. Schwartz, P.E.
(Awarding Authority) Date (County Engineer/Superintendent of Highways/Municipal Clerk)

Material Proposal or Deliver & Install Proposal

To DeKalb County Board
(Awarding Authority)

If this bid is accepted within 45 days from date of opening, the undersigned agrees to furnish or to deliver & install any or all of the materials, at the quoted unit prices, subject to the following:

- 1. It is understood and agreed that the "Standard Specifications for Road and Bridge Construction", adopted January 1, 2012, and the "Supplemental Specifications and Recurring Special Provisions", adopted January 1, 2015, prepared by the Department of Transportation, shall govern insofar as they may be applied and insofar as they do not conflict with the special provisions and supplemental specifications attached hereto.
2. It is understood that quantities listed are approximate only and that they may be increased or decreased as may be needed to properly complete the improvement within its present limits or extensions thereto, at the unit price stated and that bids will be compared on the basis of the total price bid for each group.
3. Delivery in total or partial shipments as ordered shall be made within the time specified in the special provisions or by the acceptance at the point and in the manner specified in the "Schedule of Prices". If delivery on the job site is specified, it shall mean any place or places on the road designated by the awarding authority or its authorized representative.
4. The contractor and/or local agency performing the actual material placement operations shall be responsible for providing work zone traffic control, unless otherwise specified in this proposal. Such devices shall meet the requirements of and be installed in accordance with applicable provisions of the "Illinois Manual on Uniform Traffic Control Devices" and any referenced Illinois Highway Standards.
5. Each pay item should have a unit price and a total price. If no total price is shown or if there is a discrepancy between the product of the unit price multiplied by the quantity, the unit price shall govern. If a unit price is omitted, the total price will be divided by the quantity in order to establish a unit price. A bid will be declared unacceptable if neither a unit price nor a total price is shown.

Discounts will be allowed for payment as follows: 0 % 0 calendar days: 0 % 0 calendar days.

Discounts will not be considered in determining the low bidder.

Bidder By (Signature)

Address Title



Return with Bid

Route	<u>Various</u>
County	<u>DeKalb</u>
Local Agency	<u>DeKalb County</u>
Section	<u>2015 Rejuvenator</u>

All contractors are required to complete the following certification:

- For this contract proposal or for all groups in this deliver and install proposal.
- For the following deliver and install groups in this material proposal:

Illinois Department of Transportation policy, adopted in accordance with the provisions of the Illinois Highway Code, requires this contract to be awarded to the lowest responsive and responsible bidder. The award decision is subject to approval by the Department. In addition to all other responsibility factors, this contract or deliver and install proposal requires all bidders and all bidders' subcontractors to disclose participation in apprenticeship or training programs that are (1) approved by and registered with the United States Department of Labor's Bureau of Apprenticeship and Training, and (2) applicable to the work of the above indicated proposals or groups. Therefore, all bidders are required to complete the following certification:

- I. Except as provided in paragraph IV below, the undersigned bidder certifies that it is a participant, either as an individual or as part of a group program, in an approved apprenticeship or training program applicable to each type of work or craft that the bidder will perform with its own employees.
- II. The undersigned bidder further certifies for work to be performed by subcontract that each of its subcontractors submitted for approval either (A) is, at the time of such bid, participating in an approved, applicable apprenticeship or training program; or (B) will, prior to commencement of performance of work pursuant to this contract, establish participation in an approved apprenticeship or training program applicable to the work of the subcontract.
- III. The undersigned bidder, by inclusion in the list in the space below, certifies the official name of each program sponsor holding the Certificate of Registration for all of the types of work or crafts in which the bidder is a participant and that will be performed with the bidder's employees. Types of work or craft that will be subcontracted shall be included and listed as subcontract work. The list shall also indicate any type of work or craft job category for which there is no applicable apprenticeship or training program available.

IV. Except for any work identified above, any bidder or subcontractor that shall perform all or part of the work of the contract or deliver and install proposal solely by individual owners, partners or members and not by employees to whom the payment of prevailing rates of wages would be required, check the following box, and identify the owner/operator workforce and positions of ownership.

The requirements of this certification and disclosure are a material part of the contract, and the contractor shall require this certification provision to be included in all approved subcontracts. The bidder is responsible for making a complete report and shall make certain that each type of work or craft job category that will be utilized on the project is accounted for and listed. The Department at any time before or after award may require the production of a copy of each applicable Certificate of Registration issued by the United States Department of Labor evidencing such participation by the contractor and any or all of its subcontractors. In order to fulfill the participation requirement, it shall not be necessary that any applicable program sponsor be currently taking or that it will take applications for apprenticeship, training or employment during the performance of the work of this contract or deliver and install proposal.

Bidder: _____

By: _____

(Signature)

Address: _____

Title: _____



Affidavit of Illinois Business Office

County DeKalb
Local Public Agency DeKalb Highway Dept
Section Number 2015 Rejuvenator
Route Various

State of _____)
County of _____) ss.

I, _____ of _____, _____,
(Name of Affiant) (City of Affiant) (State of Affiant)

being first duly sworn upon oath, states as follows:

- 1. That I am the _____ of _____ bidder
officer or position
2. That I have personal knowledge of the facts herein stated.
3. That, if selected under this proposal, _____, will maintain a
(bidder)
business office in the State of Illinois which will be located in _____ County, Illinois.
4. That this business office will serve as the primary place of employment for any persons employed in the
construction contemplated by this proposal.
5. That this Affidavit is given as a requirement of state law as provided in Section 30-22(8) of the Illinois
Procurement Code.

(Signature)

(Print Name of Affiant)

This instrument was acknowledged before me on _____ day of _____, _____.

(SEAL)

(Signature of Notary Public)



Illinois Department of Transportation

Bureau of Construction
2300 South Dirksen Parkway/Room 322
Springfield, Illinois 62764

Affidavit of Availability For the Letting of 4/2/2015

Instructions: Complete this form by either typing or using black ink. "Authorization to Bid" will not be issued unless both sides of this form are completed in detail. Use additional forms as needed to list all work.

Part I. Work Under Contract

List below all work you have under contract as either a prime contractor or a subcontractor. It is required to include all pending low bids not yet awarded or rejected. In a joint venture, list only that portion of the work which is the responsibility of your company. The uncompleted dollar value is to be based upon the most recent engineer's or owners estimate, and must include work subcontracted to others. If no work is contracted, show NONE.

	1	2	3	4	Awards Pending	
Contract Number						
Contract With						
Estimated Completion Date						
Total Contract Price						Accumulated Totals
Uncompleted Dollar Value if Firm is the Prime Contractor						
Uncompleted Dollar Value if Firm is the Subcontractor						
Total Value of All Work						

Part II. Awards Pending and Uncompleted Work to be done with your own forces.

List below the uncompleted dollar value of work for each contract and awards pending to be completed with your own forces. All work subcontracted to others will be listed on the reverse of this form. In a joint venture, list only that portion of the work to be done by your company. If no work is contracted, show NONE.

						Accumulated Totals
Earthwork						
Portland Cement Concrete Paving						
HMA Plant Mix						
HMA Paving						
Clean & Seal Cracks/Joints						
Aggregate Bases & Surfaces						
Highway, R.R. and Waterway Structures						
Drainage						
Electrical						
Cover and Seal Coats						
Concrete Construction						
Landscaping						
Fencing						
Guardrail						
Painting						
Signing						
Cold Milling, Planning & Rotomilling						
Demolition						
Pavement Markings (Paint)						
Other Construction (List)						
Totals						

Disclosure of this information is **REQUIRED** to accomplish the statutory purpose as outlined in the "Illinois Procurement Code." Failure to comply will result in non-issuance of an "Authorization To Bid." This form has been approved by the State Forms Management Center.

Part III. Work Subcontracted to Others.

For each contract described in Part I, list all the work you have subcontracted to others.

	1	2	3	4	Awards Pending
Subcontractor					
Type of Work					
Subcontract Price					
Amount Uncompleted					
Subcontractor					
Type of Work					
Subcontract Price					
Amount Uncompleted					
Subcontractor					
Type of Work					
Subcontract Price					
Amount Uncompleted					
Subcontractor					
Type of Work					
Subcontract Price					
Amount Uncompleted					
Subcontractor					
Type of Work					
Subcontract Price					
Amount Uncompleted					
Total Uncompleted					

I, being duly sworn, do hereby declare that this affidavit is a true and correct statement relating to ALL uncompleted contracts of the undersigned for Federal, State, County, City and private work, including ALL subcontract work, ALL pending low bids not yet awarded or rejected and ALL estimated completion dates.

Subscribed and sworn to before me

this _____ day of _____, _____ Type or Print Name _____
Officer or Director Title

 Notary Public

My commission expires _____

(Notary Seal)

Signed _____

Company _____

Address _____

LOCATION MAP DEKALB COUNTY

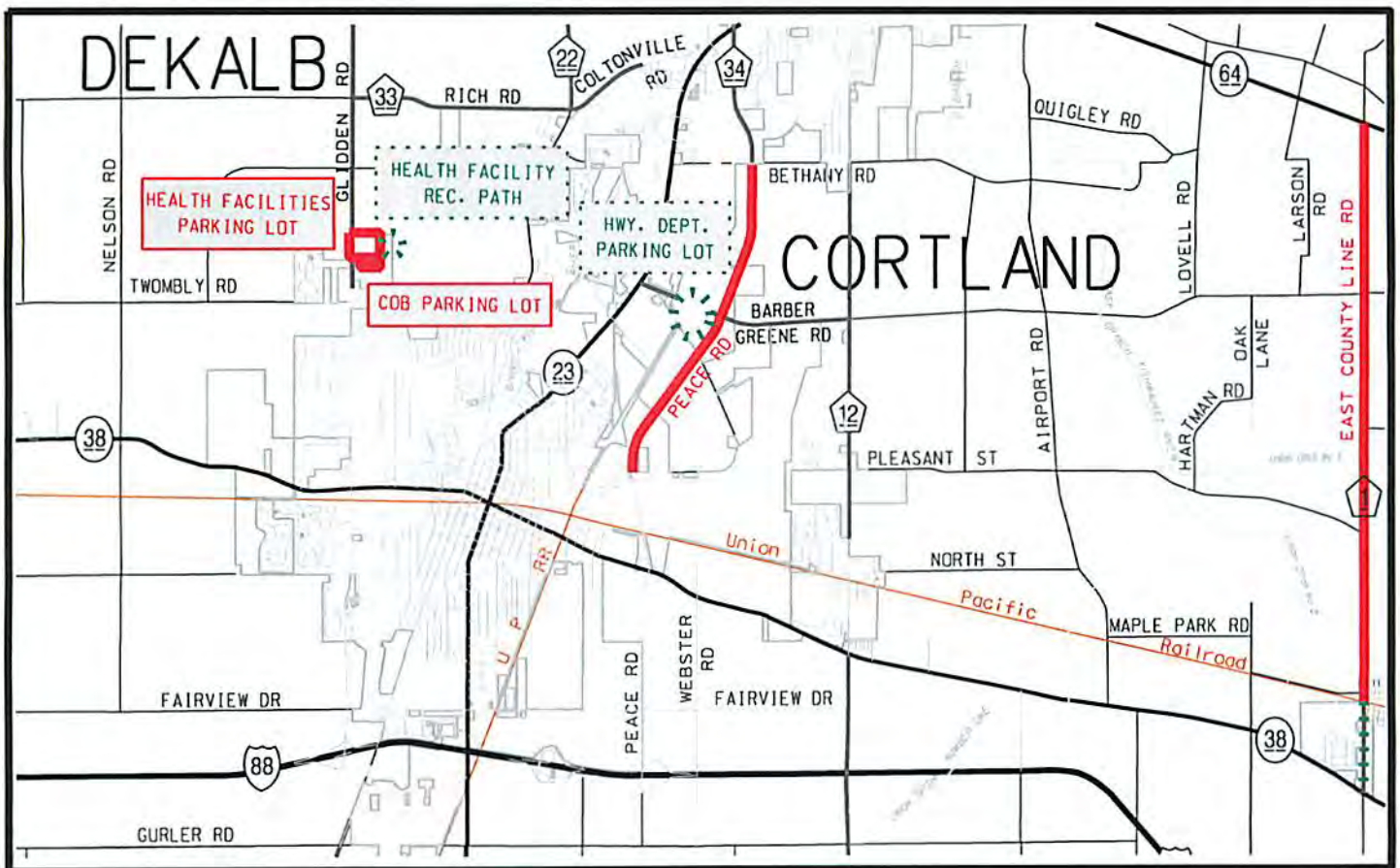
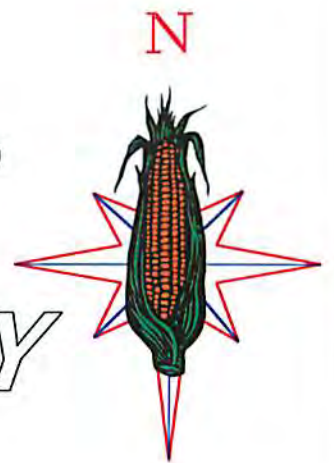

SECTION 2015 REJUVENATOR
DEKALB COUNTY HIGHWAY DEPARTMENT
LOCATION OF PROPOSED REJUVINATOR / CRF

MAYFIELD TWP.

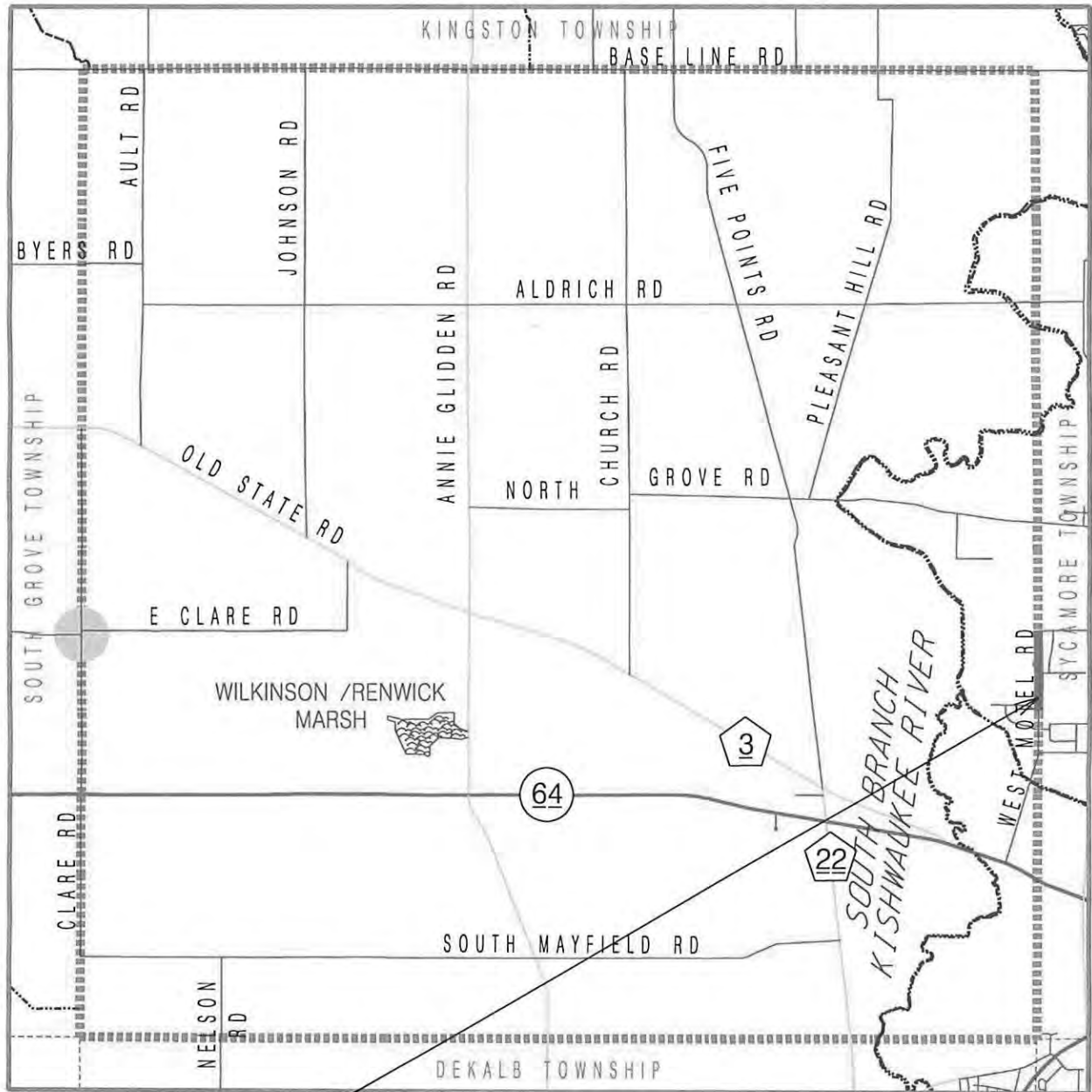

2015 DeKalb County Rejuvenator
Mayfield Township Road District
Motel Road - Dovetail Pt. to Sycamore Township Line
(Omit bridge deck north of Dovetail Pt.)

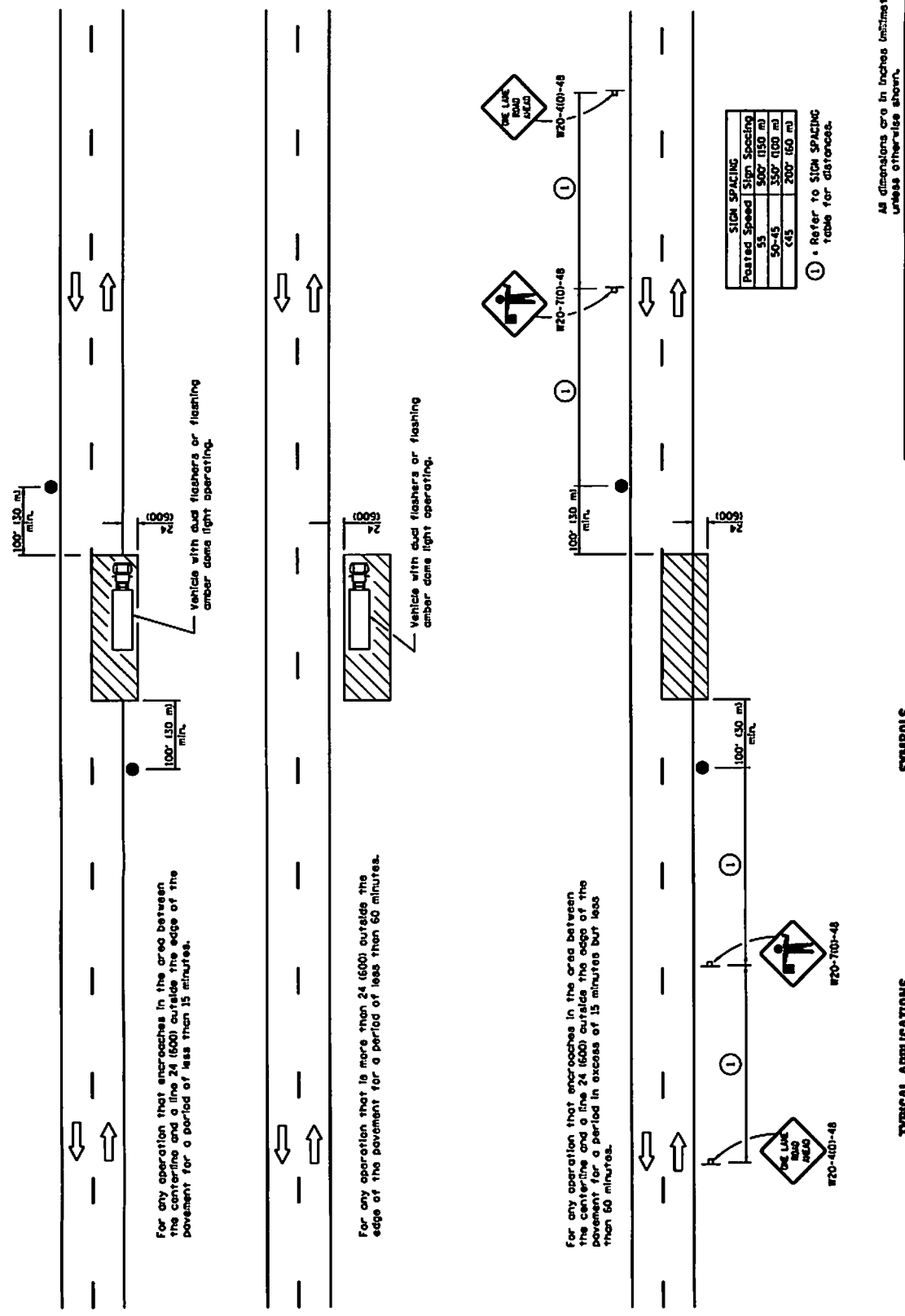

For any operation that encroaches in the area between the centerline and a line 24 (600) outside the edge of the pavement for a period of less than 15 minutes.

For any operation that is more than 24 (600) outside the edge of the pavement for a period of less than 60 minutes.

For any operation that encroaches in the area between the centerline and a line 24 (600) outside the edge of the pavement for a period in excess of 15 minutes but less than 60 minutes.

Posted Speed	Sign Spacing
55	500' (150 m)
50-45	350' (100 m)
<45	200' (60 m)

① Refer to SIGN SPACING table for distances.

All dimensions are in inches unless otherwise shown.

DATE	REVISIONS
1-1-11	Revised flagger align.
1-1-09	Switched units to English metric.

TYPICAL APPLICATIONS
 Marking patches
 Field survey
 String line
 Utility operations
 Cleaning up debris on pavement

SYMBOLS

- Mark area
- Sign on portable or permanent support
- Flagger with traffic control sign

TYPICAL APPLICATIONS

- Marking patches
- Field survey
- String line
- Utility operations
- Cleaning up debris on pavement

Illinois Department of Transportation

ISSUED 1-1-97

APPROVED [Signature] 2011

DESIGNED [Signature] 2011

APPROVED [Signature] 2011

CHIEF OF BUREAU AND ENGINEER

**LANE CLOSURE, 2L, 2W,
SHORT TIME OPERATIONS**

STANDARD 701301-04

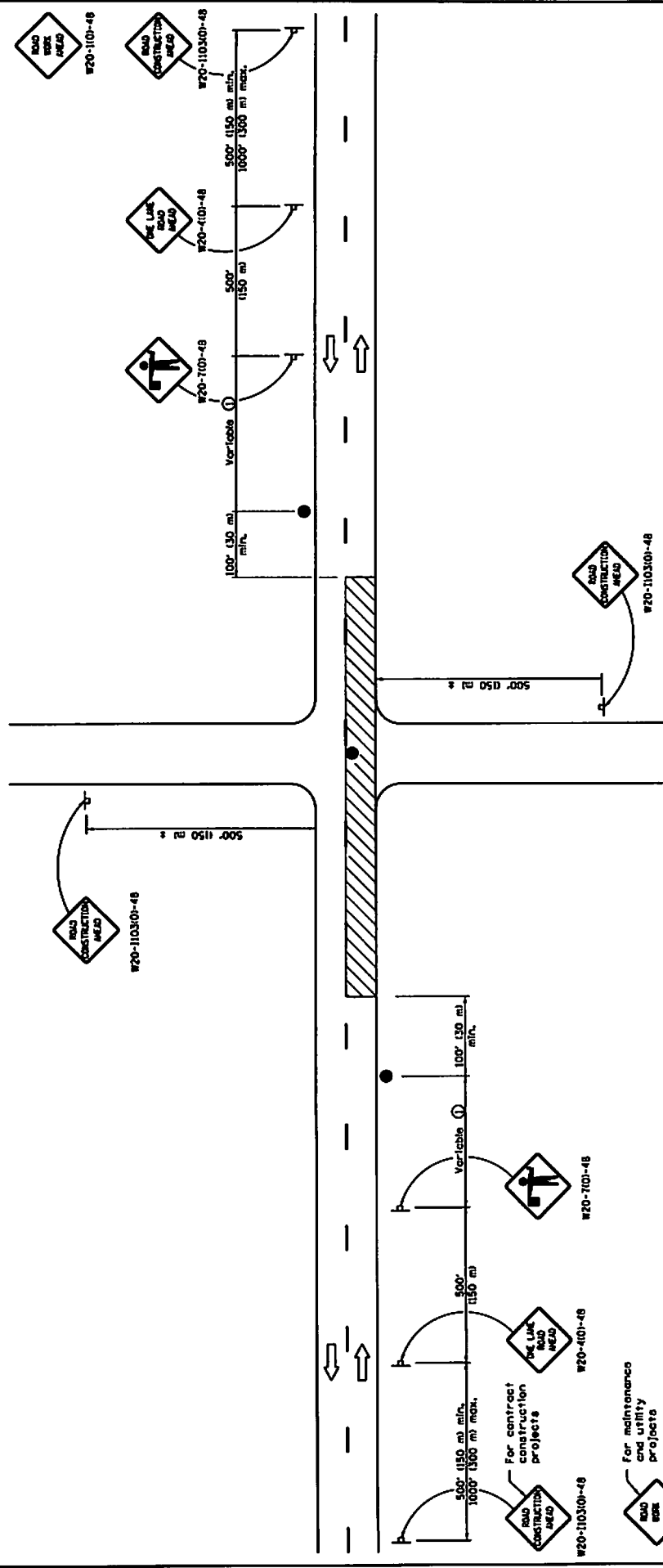

GENERAL NOTES

This Standard is used where at any time, any vehicle, equipment, workers or their activities require an intermittent or continuous moving operation on the pavement where the average speed of movement is greater than 1 mph (2 km/h) and less than 4 mph (6 km/h). When the operation does not exceed 60 minutes, traffic control may be according to Standard 701300. All dimensions are in inches (centimeters) unless otherwise shown.

① Minimum distance is 200' (60 m). Maximum distance to be determined by the Engineer but should not exceed 1/2 the length required for one normal working day's operation or 2 miles (3200 m), whichever is less.

TYPICAL APPLICATIONS

- Bituminous resurfacing
- Moving operations
- Utility operations
- Shoulder operations

SYMBOLS

- ▨ Work crew
- ⊥ Sign on portable or permanent support
- Flagger with traffic control sign

DATE	REVISIONS
1-1-11	Revised flagger sign.
1-1-09	Switched units to English (metric).
	Corrected sign No.'s.

LANE CLOSURE, 2L, 2W, SLOW MOVING OPERATIONS DAY ONLY, FOR SPEEDS ≥ 45 MPH

STANDARD 701300-03

Iowa Department of Transportation		ISSUED 1-1-97
APPROVED	DESIGNED	BY
APPROVED	DESIGNED	BY
APPROVED	DESIGNED	BY

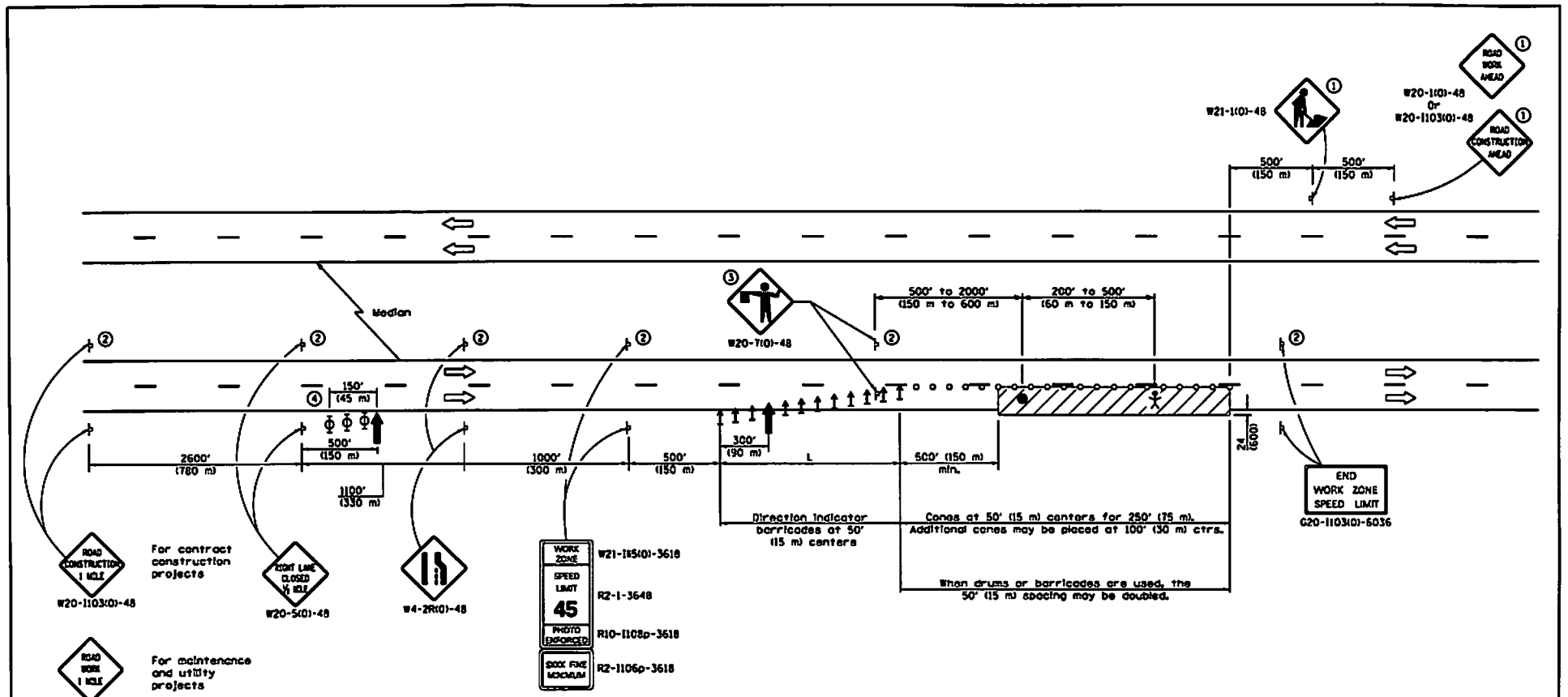

For contract construction projects



For maintenance and utility projects



W20-501-48



W4-2R(1)-48

WORK ZONE

SPEED LIMIT

45

PHOTO ENFORCED

BOX FARE MINIMUM

W21-105(1)-3618

R2-1-3648

R10-1108a-3618

R2-1106p-3618

L = lane width X taper ratio

Normal Posted Speed	Taper Ratio
mph	
55	55/1
45	45/1

SYMBOLS

- ↑ Arrow board
- ▨ Work area
- ↑ Sign
- ↑ Direction Indicator barricade
- Cone, drum or barricade
- Flagger with traffic control sign
- ⊕ Worker
- ⊕ Type II barricade, drum, or vertical barricade with mono-directional flashing light

- ① Undivided roadway only with left lane closure in opposite direction.
- ② Omitted when median is less than 10' (3 m).
- ③ FLAGGER signs shall be moved as necessary to maintain the required spacing between the sign and each separate work activity.
- ④ Three Type II barricades, drums, or vertical barricades at 50' (15 m) centers.

GENERAL NOTES

This Standard is used where at any time, any vehicle, equipment, workers or their activities will encroach on the lane adjacent to the shoulder, or on the shoulder within 24 (600) of the edge of pavement.

This Standard also applies when work is being performed in the left lane. Under these conditions, LEFT LANE CLOSED signs shall be substituted for RIGHT LANE CLOSED signs. On undivided highways, signs shall be added in the opposite direction as shown.

All dimensions are in inches (millimeters) unless otherwise shown.

Illinois Department of Transportation

APPROVED: [Signature] January 1, 2015

MEMBER OF SAFETY ENGINEERING

ISSUED: 1-1-04

ILLINOIS DEPARTMENT OF TRANSPORTATION

DATE	REVISIONS
1-1-15	Revised END WORK ZONE SPEED LIMIT sign dimensions.
1-1-14	Revised workers sign number to agree with current MUTCD.
	Rev. PHOTO ENFORCED sign no.

LANE CLOSURE, MULTILANE, DAY OPERATIONS ONLY, FOR SPEEDS ≥ 45 MPH TO 55 MPH

STANDARD 701421-07

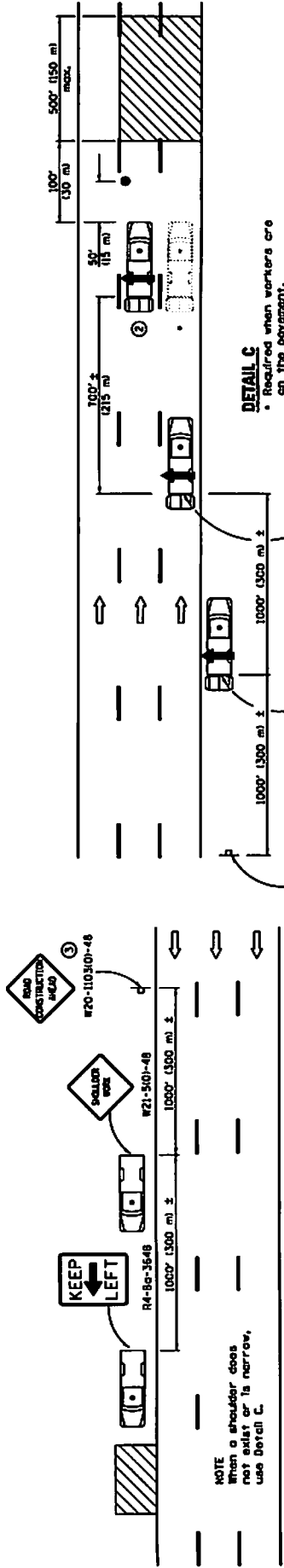

DETAIL A

TYPICAL APPLICATIONS
 Landscaping work
 Utility work
 Pavement marking
 Weed spraying
 Roadometer measurements
 Debris cleanup
 Crack pouring

DETAIL C

• Required when workers are on the pavement.

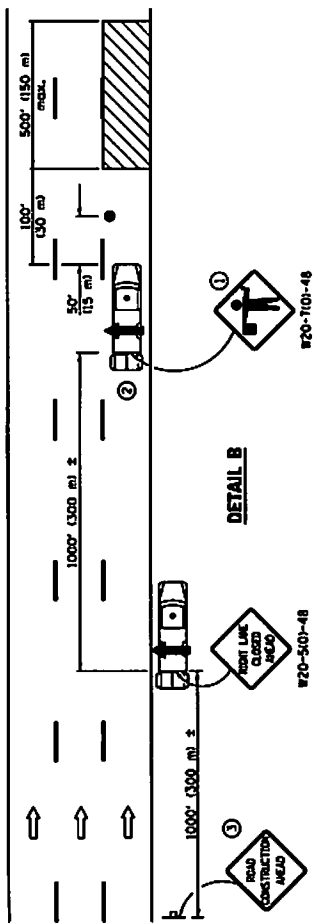

DETAIL B

- ① Flaggers are required when workers are on the pavement.
- ② For striping operations only. See sign arrow detail on this standard.
- ③ For stationary operations which are on the roadway or shoulder, greater than 15 minutes and up to 1 hour.



C20-1101-2430
 (operators, arrow)
 ② when striping only

GENERAL NOTES

This Standard is used where any vehicle, equipment, workers or their activities will require: 1) stationary operations up to 1 hour, or 2) a continuous or intermittent moving operation where the average speed of movement is greater than 1 mph (2 km/h).

This Standard is also applicable when work is being performed in the left lane(s) or on the median shoulder. Under these conditions, KEEP RIGHT signs shall be substituted for KEEP LEFT signs and arrow board indications shall be directed to the right.

The distance between the work and shadow vehicles may vary according to terrain or paint / crack sealing drying time.

All dimensions are in inches (millimeter) unless otherwise shown.

SYMBOLS

- ↑ Arrow board
- ▨ Work area
- Truck with flashing amber light
- Truck mounted attenuator
- Flagger with traffic control sign
- ⊥ Sign

LANE CLOSURE, MULTILANE, INTERMITTENT OR MOVING OPER., FOR SPEEDS ≥ 45 MPH

STANDARD 701426-07

DATE	REVISIONS
1-1-15	Added general note regarding vehicle spacing.
	Corr. KEEP LEFT sign no.
1-1-14	Corrected sign in DETAIL B.
	Added ' to distances behind shadow vehicles.

Illinois Department of Transportation

ISSUED 1-1-97

APPROVED: [Signature] 2015

DESIGNED BY: [Signature]

APPROVED: [Signature] 2015

REGISTERED PROFESSIONAL ENGINEER

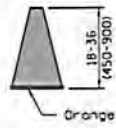

CONE

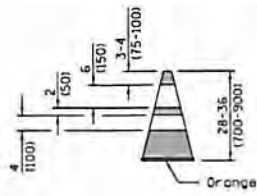

REFLECTORIZED CONE

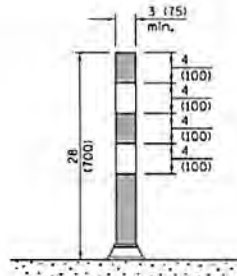

FLEXIBLE DELINEATOR

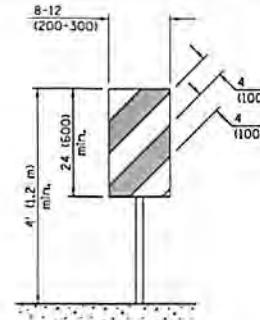

**VERTICAL PANEL
POST MOUNTED**

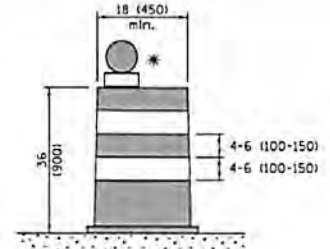

DRUM

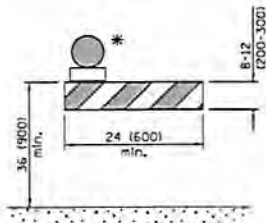

TYPE I BARRICADE

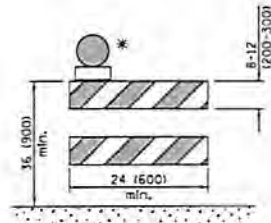

TYPE II BARRICADE

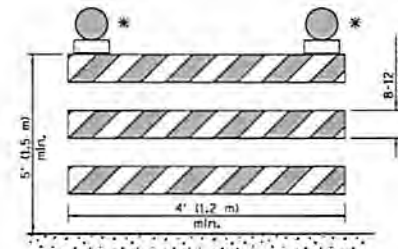

TYPE III BARRICADE

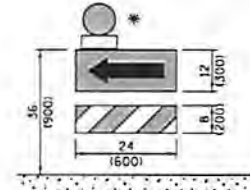

**DIRECTION INDICATOR
BARRICADE**

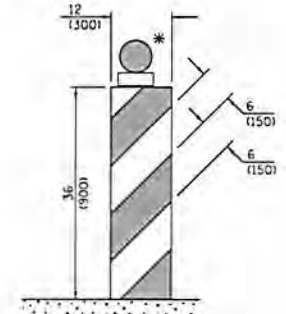

VERTICAL BARRICADE

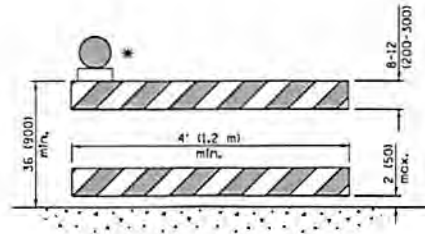

**DETECTABLE PEDESTRIAN
CHANNELIZING BARRICADE**

* Warning lights (if required)

GENERAL NOTES

All heights shown shall be measured above the pavement surface.

All dimensions are in inches (millimeters) unless otherwise shown.

Illinois Department of Transportation
 APPROVED January 1, 2015
 ENGINEER OF OPERATIONS
 APPROVED January 1, 2015
 DIVISION OF DESIGN AND ENVIRONMENT

DATE	REVISIONS
1-1-15	Revised two sign numbers on sheet 2. Added note re: PHOTO ENFORCED plaque.
1-1-14	Modified flagger sign height. Added highway construction speed zone signs.

**TRAFFIC CONTROL
DEVICES**

(Sheet 1 of 3)

STANDARD 701901-04

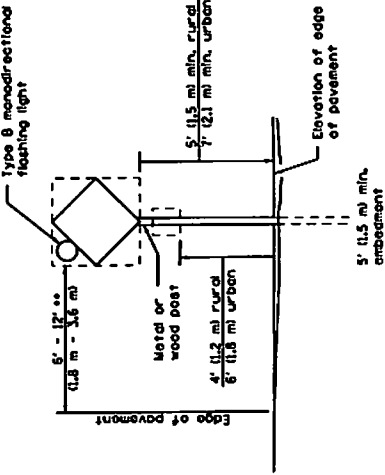

POST MOUNTED SIGNS

** When curb or paved shoulder are present this dimension shall be 24 (600) to the face of curb or 5' (1.5 m) to the outside edge of the paved shoulder.

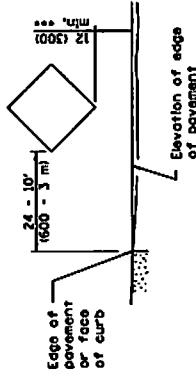

SIGNS ON TEMPORARY SUPPORTS

*** When work operations exceed four days, this dimension shall be 5' (1.5 m) min. If located in urban areas, this height shall be sufficient to be seen completely above the devices.

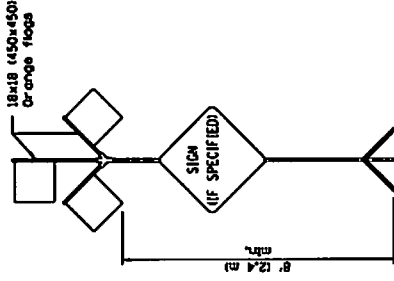

HIGH LEVEL WARNING DEVICE

ROAD CONSTRUCTION NEXT X MILES
C20-1104(0)-6036

END CONSTRUCTION
C20-1109(0)-6024

This signing is required for all projects 2 miles (3200 m) or more in length.

ROAD CONSTRUCTION NEXT X MILES sign shall be placed 500 (150 m) in advance of project limits.

END CONSTRUCTION sign shall be erected at the end of the job unless another job is within 2 miles (3200 m).

Dual sign displays shall be utilized on multi-lane highways.

WORK LIMIT SIGNING

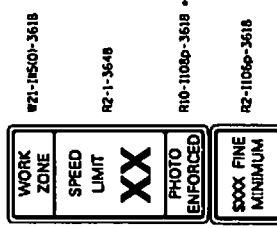

Sign assembly as shown on Standard or as covered by District Operations.

END WORK ZONE SPEED LIMIT
C20-1103(0)-6035

This sign shall be used when the above sign assembly is used.

HIGHWAY CONSTRUCTION SPEED ZONE SIGNS

**** R10-1108D shall only be used along roadways under the jurisdiction of the State.

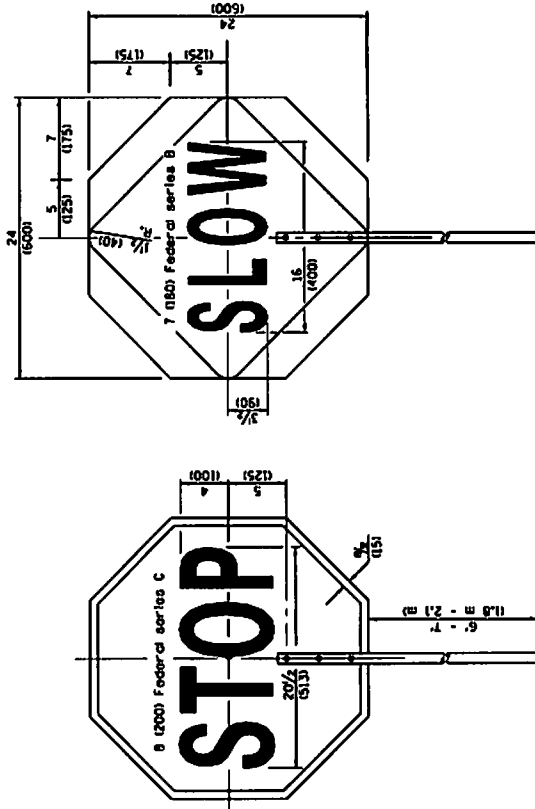

REVERSE SIDE

FRONT SIDE

FLAGGER TRAFFIC CONTROL SIGN

TRAFFIC CONTROL DEVICES
(Sheet 2 of 3)

STANDARD 701901-04

Illinois Department of Transportation
 APPROVED: _____ DATE: 2015
 EXAMINED: _____ DATE: 2015
 APPROVED: _____ DATE: 2015
 ILLINOIS STATE UNIVERSITY

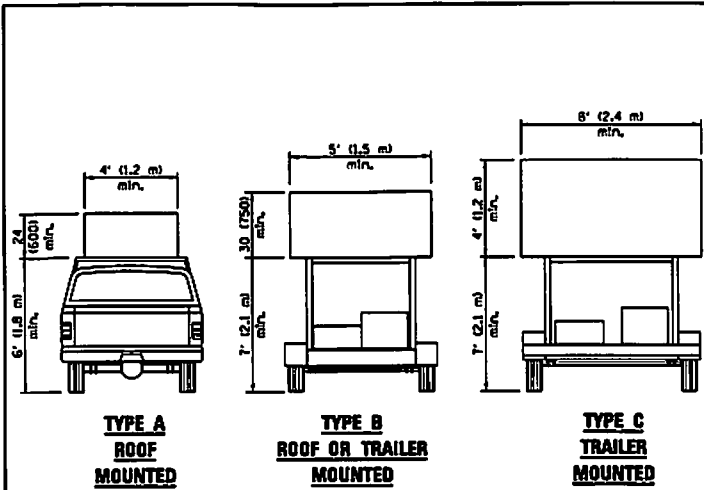

ARROW BOARDS

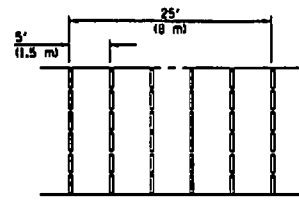
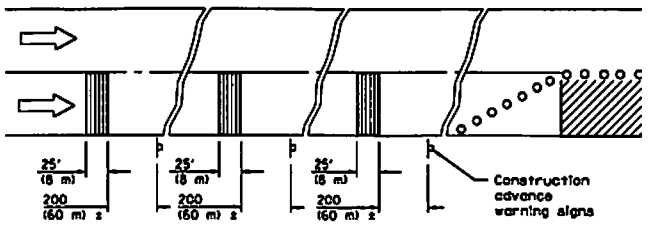
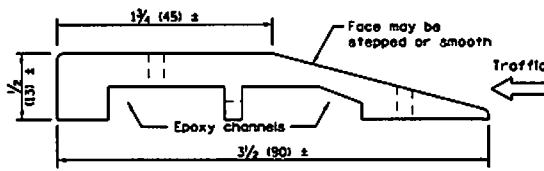
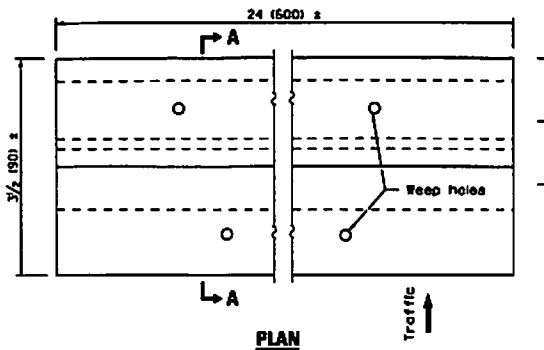

TYPICAL INSTALLATION

TEMPORARY RUMBLE STRIPS

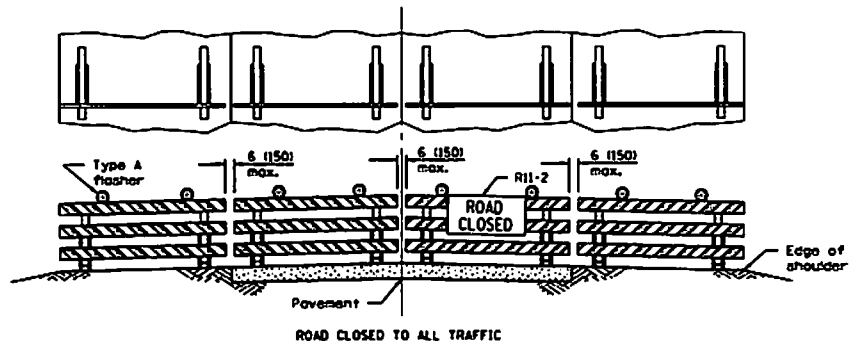

ReflectORIZED striping may be omitted on the back side of the barricades. If a Type III barricade with an attached sign panel which meets NCHRP 350 is not available, the sign may be mounted on an NCHRP 350 temporary sign support directly in front of the barricade.

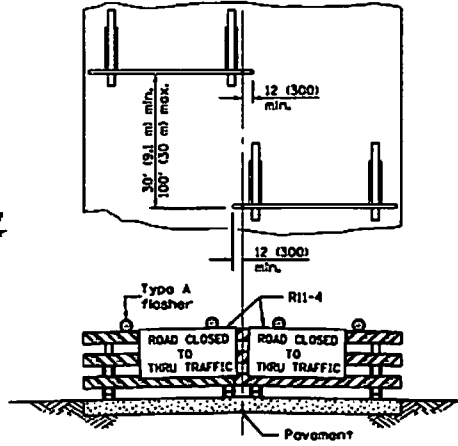

ReflectORIZED striping shall appear on both sides of the barricades. If a Type III barricade with an attached sign panel which meets NCHRP 350 is not available, the signs may be mounted on NCHRP 350 temporary sign supports directly in front of the barricade.

**TYPICAL APPLICATIONS OF
TYPE III BARRICADES CLOSING A ROAD**

Idaho Department of Transportation

APPROVED: [Signature] JUNE 1, 2015
ENGINEER OF OPERATIONS

APPROVED: [Signature] JUNE 1, 2015
DIRECTOR OF DESIGN AND ENVIRONMENT

16-1-1, CONTROL

**TRAFFIC CONTROL
DEVICES**

(Sheet 3 of 3)

STANDARD 701901-04

**INDEX
FOR
SUPPLEMENTAL SPECIFICATIONS
AND RECURRING SPECIAL PROVISIONS**

Adopted January 1, 2015

This index contains a listing of SUPPLEMENTAL SPECIFICATIONS, frequently used RECURRING SPECIAL PROVISIONS, and LOCAL ROADS AND STREETS RECURRING SPECIAL PROVISIONS.

ERRATA Standard Specifications for Road and Bridge Construction
(Adopted 1-1-12) (Revised 1-1-15)

SUPPLEMENTAL SPECIFICATIONS

<u>Std. Spec. Sec.</u>	<u>Page No.</u>
101 Definition of Terms	1
102 Advertisement, Bidding, Award, and Contract Execution	2
105 Control of Work	3
106 Control of Materials	5
107 Legal Regulations and Responsibility to Public	6
108 Prosecution and Progress	14
109 Measurement and Payment	15
202 Earth and Rock Excavation	17
211 Topsoil and Compost	19
250 Seeding	20
253 Planting Woody Plants	21
280 Temporary Erosion and Sediment Control	23
312 Stabilized Subbase	24
406 Hot-Mix Asphalt Binder and Surface Course	25
407 Hot-Mix Asphalt Pavement (Full-Depth)	28
420 Portland Cement Concrete Pavement	32
424 Portland Cement Concrete Sidewalk	34
440 Removal of Existing Pavement and Appurtenances	35
502 Excavation for Structures	36
503 Concrete Structures	37
504 Precast Concrete Structures	40
506 Cleaning and Painting New Steel Structures	41
512 Piling	42
516 Drilled Shafts	43
521 Bearings	44
540 Box Culverts	45
588 Bridge Relief Joint System	46
589 Elastic Joint Sealer	48
602 Catch Basin, Manhole, Inlet, Drainage Structure, and Valve Vault Construction, Adjustment, and Reconstruction	49
603 Adjusting Frames and Grates of Drainage and Utility Structures	50
606 Concrete Gutter, Curb, Median, and Paved Ditch	52
610 Shoulder Inlets with Curb	53
639 Precast Prestressed Concrete Sight Screen	54
642 Shoulder Rumble Strips	55

643	Impact Attenuators	56
644	High Tension Cable Median Barrier	58
669	Removal and Disposal of Regulated Substances	60
670	Engineer's Field Office and Laboratory	64
701	Work Zone Traffic Control and Protection	65
706	Impact Attenuators, Temporary	68
707	Movable Traffic Barrier	71
708	Temporary Water Filled Barrier	73
730	Wood Sign Support	75
780	Pavement Striping	76
816	Unit Duct	81
836	Pole Foundation	82
860	Master Controller	83
1001	Cement	84
1003	Fine Aggregates	85
1004	Coarse Aggregates	87
1006	Metals	91
1011	Mineral Filler	93
1017	Packaged, Dry, Combined Materials for Mortar	94
1018	Packaged Rapid Hardening Mortar or Concrete	95
1019	Controlled Low-Strength Material (CLSM).....	96
1020	Portland Cement Concrete	97
1024	Grout and Nonshrink Grout	136
1030	Hot-Mix Asphalt	137
1040	Drain Pipe, Tile, Drainage Mat, and Wall Drain	142
1042	Precast Concrete Products	143
1069	Pole and Tower	144
1070	Foundation and Breakaway Devices	145
1073	Controller	146
1081	Materials for Planting	147
1082	Preformed Bearing Pads	148
1083	Elastomeric Bearings	149
1088	Wireway and Conduit System	150
1095	Pavement Markings	152
1101	General Equipment	155
1102	Hot-Mix Asphalt Equipment	157
1103	Portland Cement Concrete Equipment	159
1105	Pavement Marking Equipment	160
1106	Work Zone Traffic Control Devices	161

CHECK SHEET
FOR
RECURRING SPECIAL PROVISIONS

Adopted January 1, 2015

The following RECURRING SPECIAL PROVISIONS indicated by an "X" are applicable to this contract and are included by reference:

<u>CHECK SHEET #</u>	<u>RECURRING SPECIAL PROVISIONS</u>	<u>PAGE NO.</u>
1	<input type="checkbox"/> Additional State Requirements for Federal-Aid Construction Contracts	163
2	<input type="checkbox"/> Subletting of Contracts (Federal-Aid Contracts)	166
3	<input type="checkbox"/> EEO	167
4	<input type="checkbox"/> Specific EEO Responsibilities Non Federal-Aid Contracts	177
5	<input type="checkbox"/> Required Provisions - State Contracts	182
6	<input type="checkbox"/> Asbestos Bearing Pad Removal	188
7	<input type="checkbox"/> Asbestos Waterproofing Membrane and Asbestos Hot-Mix Asphalt Surface Removal	189
8	<input type="checkbox"/> Temporary Stream Crossings and In-Stream Work Pads	190
9	<input type="checkbox"/> Construction Layout Stakes Except for Bridges	191
10	<input type="checkbox"/> Construction Layout Stakes	194
11	<input type="checkbox"/> Use of Geotextile Fabric for Railroad Crossing	197
12	<input type="checkbox"/> Subsealing of Concrete Pavements	199
13	<input type="checkbox"/> Hot-Mix Asphalt Surface Correction	203
14	<input type="checkbox"/> Pavement and Shoulder Resurfacing	205
15	Reserved	206
16	<input type="checkbox"/> Patching with Hot-Mix Asphalt Overlay Removal	207
17	<input type="checkbox"/> Polymer Concrete	208
18	<input type="checkbox"/> PVC Pipeliner	210
19	<input type="checkbox"/> Pipe Underdrains	211
20	<input type="checkbox"/> Guardrail and Barrier Wall Delineation	212
21	<input type="checkbox"/> Bicycle Racks	216
22	Reserved	218
23	<input type="checkbox"/> Temporary Portable Bridge Traffic Signals	219
24	<input type="checkbox"/> Work Zone Public Information Signs	221
25	<input type="checkbox"/> Nighttime Inspection of Roadway Lighting	222
26	<input type="checkbox"/> English Substitution of Metric Bolts	223
27	<input type="checkbox"/> English Substitution of Metric Reinforcement Bars	224
28	<input type="checkbox"/> Calcium Chloride Accelerator for Portland Cement Concrete	225
29	Reserved	226
30	<input type="checkbox"/> Quality Control of Concrete Mixtures at the Plant	227
31	<input type="checkbox"/> Quality Control/Quality Assurance of Concrete Mixtures	235
32	<input type="checkbox"/> Digital Terrain Modeling for Earthwork Calculations	251
33	<input type="checkbox"/> Pavement Marking Removal	253
34	<input type="checkbox"/> Preventive Maintenance – Bituminous Surface Treatment	254
35	<input type="checkbox"/> Preventive Maintenance – Cape Seal	260
36	<input type="checkbox"/> Preventive Maintenance – Micro-Surfacing	275
37	<input type="checkbox"/> Preventive Maintenance – Slurry Seal	286
38	<input type="checkbox"/> Temporary Raised Pavement Markers	296
39	<input type="checkbox"/> Restoring Bridge Approach Pavements Using High-Density Foam	297

CHECK SHEET
FOR
LOCAL ROADS AND STREETS RECURRING SPECIAL PROVISIONS

Adopted January 1, 2015

The following LOCAL ROADS AND STREETS RECURRING SPECIAL PROVISIONS indicated by an "X" are applicable to this contract and are included by reference:

LOCAL ROADS AND STREETS RECURRING SPECIAL PROVISIONS

<u>CHECK SHEET #</u>		<u>PAGE NO.</u>
LRS 1	Reserved.....	301
LRS 2	<input type="checkbox"/> Furnished Excavation	302
LRS 3	<input checked="" type="checkbox"/> Work Zone Traffic Control Surveillance	303
LRS 4	<input type="checkbox"/> Flaggers in Work Zones	304
LRS 5	<input checked="" type="checkbox"/> Contract Claims	305
LRS 6	<input type="checkbox"/> Bidding Requirements and Conditions for Contract Proposals	306
LRS 7	<input checked="" type="checkbox"/> Bidding Requirements and Conditions for Material Proposals	312
LRS 8	Reserved.....	318
LRS 9	<input type="checkbox"/> Bituminous Surface Treatments	319
LRS 10	Reserved.....	320
LRS 11	<input checked="" type="checkbox"/> Employment Practices	321
LRS 12	<input checked="" type="checkbox"/> Wages of Employees on Public Works	323
LRS 13	<input checked="" type="checkbox"/> Selection of Labor	325
LRS 14	<input type="checkbox"/> Paving Brick and Concrete Paver Pavements and Sidewalks	326
LRS 15	<input checked="" type="checkbox"/> Partial Payments	329
LRS 16	<input checked="" type="checkbox"/> Protests on Local Lettings.....	330
LRS 17	<input checked="" type="checkbox"/> Substance Abuse Prevention Program	331
LRS 18	<input type="checkbox"/> Multigrade Cold Mix Asphalt	332



Special Provisions

The following Special Provisions supplement the “Standard Specifications for Road and Bridge Construction”, Adopted January 1, 2012, the latest edition of the “Manual on Uniform Traffic Control Devices for Roads and Highways”, and the “Manual of Test Procedures of Materials” in effect on the date of invitation of bids, and the Supplemental Specifications and Recurring Special Provisions indicated on the Check Sheet included here in which apply to and govern the construction of Section 2015 Rejuvenator, and in case of conflict with any part, or parts, of said Specifications, the said Special Provisions shall take precedence and shall govern.

DESCRIPTION OF WORK The work of this section shall consist of the application of Rejuvenator-Reclamite and Rejuvenator-CRF on the mainline and paved shoulders on various roads and various parking lots in DeKalb County.

LOCATIONS OF WORK The work shall be applied on the following roads:

DeKalb County

Rejuvenator
- Reclamite

<u>Location</u>	<u>Begin</u>	<u>End</u>	<u>Length (mi)</u>	<u>Width (ft)</u>	<u>Area (SY)</u>
East County Line Road	RR Tracks in Maple Park	Route 64	1.27	29.5	21,900
Peace Road	Pleasant Street	Bethany Road	2.74	71.2	114,400
Health Facilities Parking Lot					23,470
COB Parking Lot					<u>2,340</u>
				Total (SY)	162,110

Rejuvenator
- CRF

<u>Location</u>	<u>Begin</u>	<u>End</u>	<u>Length (mi)</u>	<u>Width (ft)</u>	<u>Area (SY)</u>
East County Line Road	Route 38	RR Tracks in Maple Park	0.65	27-50	17,435
Hwy Dept Parking Lot					13,290
Health Facility Rec Path					<u>10,890</u>
				Total (SY)	41,615

Mayfield Township

Rejuvenator
- Reclamite

<u>Location</u>	<u>Begin</u>	<u>End</u>	<u>Length (mi)</u>	<u>Width (ft)</u>	<u>Area (SY)</u>
Motel Road	north ROW of Dovetail Pt	Sycamore Township Line	0.47	20.0	5,550

The Health Facilities Parking Lot is located at 2550 North Annie Glidden Road, Dekalb, IL. The COB (Communications Outreach Building) Parking Lot is located at 2500 North Annie Glidden Road. The work for these parking lots will need to be coordinated with the Engineer. Multiple days will be required to complete these parking lots.

The Hwy Dept Parking Lot is located at 1826 Barber Greene Road, DeKalb, IL. Again coordination with the Engineer will be required to complete this work.

PROSECUTION OF WORK The Contractor shall notify the Engineer a minimum of two (2) working days (i.e. notice given on Thursday AM for work to begin the following Monday) prior to the commencement of any work which could be considered as a pay item in the contract. The Contractor shall notify the Engineer a minimum of one week prior to the commencement of any work to be completed on any parking lots. No payment will be made to the Contractor for any pay item work performed without the aforementioned notice being given unless otherwise approved by the Engineer.

MOBILIZATION - Section 671 in the Standard Specifications shall be deleted and no advance payment for Mobilization shall be granted.

SPECIAL PROVISION FOR BIDDING REQUIREMENTS AND CONDITIONS FOR MATERIAL PROPOSALS (LRS7):

Prequalification of Bidders The provisions for prequalification of bidders as stated in the second paragraph shall not apply to this proposal.

Requirement of Contract Bond Revise to read: If successful low bidder has submitted a proposal guaranty check, it will be held by the County as the contract bond. The Contractor's check will be held until the successful completion of the work and certification of material approval, upon which time, the check will be returned to the Contractor.

PREVAILING WAGE The Contractor(s) shall pay prevailing wage to employees on this project in accordance with LR107-7. The Contractor shall be responsible for obtaining the monthly rate sheet from the Illinois Department of Labor. These sheets are also available at the DeKalb County Clerk's office or at: <http://www.illinois.gov/idol/Laws-Rules/CONMED/Pages/Rates.aspx>.

REJUVENATOR – RECLAMITE

GENERAL SCOPE This work shall consist of furnishing all labor, material and equipment necessary to perform all operations for the application of an emulsified maltene-based asphalt rejuvenating agent to bituminous asphaltic concrete surface courses. The rejuvenation of surface courses shall be by spray application of a cationic maltene-based rejuvenating agent composed of petroleum oils and resins emulsified with water. All work shall be in accordance with the specifications, any applicable drawings, and subject to the terms and conditions of this contract.

PRE-CONSTRUCTION The CONTRACTOR shall present samples of materials, laboratory reports, calibration reports, and proof of work experience as required by these specifications to the Resident Engineer at the pre-construction meeting.

MATERIAL SPECIFICATIONS The asphalt rejuvenating agent shall be an emulsion composed of a petroleum resin oil base uniformly emulsified with water. Each bidder must submit with his bid a certified statement from the asphalt rejuvenator manufacturer showing that the asphalt rejuvenating emulsion conforms to the required physical and chemical requirements.

ASPHALT REJUVENATOR SPECIFICATIONS

Property	Test Method	Requirements	
		Min.	Max.
Viscosity @ 25°C, SFS	ASTM D244	15	40
Residue, w%	D244 (Mod) ³	60	65
Miscibility Test	D244 (Mod) ²		Pass

Sieve Test, w%	D244 (Mod) ¹	-	0.1
Particle Charge Test	D244		Positive
Tests on Distillation Residue:			
Flash Point, COC, C	D92	196	-
Viscosity@ 60C, C	D2170	100	200
Asphaltenes, %w	D2006-70	-	1.00
Maltene Oist. Ratio (Polar Compounds) + (First Acidaffins) (Saturates) + (Second Acidaffins)	D2006-70	0.3	0.6
Polar Compounds/Saturates Ratio	D2006-70	0.5	
Asphaltenes, w%	D2006-70		1.0
Saturated Hydrocarbons, w%	D2006-70	21	28

¹ Test procedure identical with ASTM 0-244 except that distilled water shall be used in place of two (2) percent sodium oleate solution.

² Test procedure identical with ASTM 0-244 except that .02 Normal Calcium Chloride solution shall be used in place of distilled water.

³ ASTM 0-244 Modified Evaporation Test for percent of residue is made by heating 50 gram sample to 149 C (300 F) until foam ceases, then cool immediately and calculate results.

MATERIAL PERFORMANCE The rejuvenating agent shall have record of at least two years of satisfactory service as asphalt rejuvenating agent and in-depth sealer. Satisfactory service shall be based on the capability of the material to penetrate, replace lost maltene fractions, and decrease the viscosity and increase the penetration value of the in-place asphalt binder as follows; the viscosity shall be reduced by a minimum of forty-five (45) percent, the penetration value shall be increased by a minimum of twenty-five (25) percent. Testing shall be performed by an independent testing laboratory on extracted asphalt cement from pavement to a depth of three-eighths inch (3/8"). In addition, the pavement shall be in-depth sealed to the intrusion of air and water.

The bidder must submit with their bid:

1. Asphalt Rejuvenator product name and descriptive literature. Literature shall be descriptive and detailed information and shall show it at least meets the material specifications.
2. A current Material Safety Data Sheet (MSDS) for the material.
3. The manufacturer's certification that the material proposed for use is in compliance with these specification requirements.
4. Previous use documentation and test data conclusively demonstrating that the rejuvenating agent has been used successfully for a period of two years by government agencies such as Cities, Counties, or DOTs.
5. Testing data from a minimum of five projects showing that the asphalt rejuvenating agent has been proven to perform, as heretofore required, through field testing by an independent testing laboratory as to the required change in the asphalt binder viscosity and penetration number.

PRODUCT STANDARDS The PRODUCT "Reclamite"® produced by Tricor Refining, LLC is the standard for the naphthenic emulsified maltene-based asphalt rejuvenating agent requirements and the prices quoted on the Material Proposal Schedule of Prices shall be for one of these standards.

APPLICATOR EXPERIENCE The asphalt rejuvenating agent shall be applied by an experienced applicator of such material. The bidder shall have a minimum of three years experience in applying the product proposed for use on municipal roads. The Contractor must submit with his bid a list of five (5) projects on which he applied said

rejuvenator. He shall indicate the project dates, number of square yards treated in each and the name and phone number of the manager in charge of each project.

A project superintendent knowledgeable and experienced in application of the asphalt rejuvenating agent must be present and in control of each days work. The bidder shall submit at the preconstruction meeting a written experience outline of the project superintendent.

APPLICATION TEMPERATURE AND WEATHER LIMITATIONS The temperature of the asphalt rejuvenation emulsion, at the time of application shall be as recommended by the manufacturer. The asphalt rejuvenating agent shall be applied only when the existing surface to be treated is thoroughly dry and when there is no likelihood of precipitation forecasted within twenty-four (24) hours of application. The asphalt rejuvenating agent shall not be applied when the ambient temperature is below 50 degrees Fahrenheit or when temperatures are forecasted to fall below 40 degrees Fahrenheit within twenty-four (24) hours of application. It shall be the discretion of the Resident Engineer to determine when weather conditions are not appropriate for the application to occur. Contractor shall halt the application process when so ordered by the Resident Engineer.

HANDLING OF ASPHALT REJUVENATING AGENT Contents in tank cars or storage tanks shall be circulated at least forty-five minutes before withdrawing any material for application. When loading the distributor, the asphalt rejuvenating agent concentrate shall be loaded first and then the required amount of water shall be added. The water shall be added into the distributor with enough force to cause agitation and thorough mixing of the two (2) materials. To prevent foaming, the discharge end of the water hose or pipe shall be kept below the surface of the material in the distributor which shall be used as a spreader. The distributor truck will be cleaned of all of its asphalt materials, and washed out to the extent that no discoloration of the emulsion may be perceptible. Cleanliness of the spreading equipment shall be subject to inspection and the Contractor shall halt the application process when so ordered by the Resident Engineer.

APPLICATION EQUIPMENT The distributor for spreading the emulsion shall be self-propelled, and shall have pneumatic tires. The distributor shall be designed and equipped to distribute the asphalt rejuvenating agent uniformly on variable widths of surface at readily determined and controlled rates from 0.05 to 0.5 gallons per square yard of surface, and with an allowable variation from any specified rate not to exceed five (5) percent of the specified rate. Distributor equipment shall include full circulation spray bars, pump tachometer, volume measuring device and a hand hose attachment suitable for application of the emulsion manually to cover areas inaccessible to the distributor. The distributor shall be equipped to circulate and agitate the emulsion within the tank. A check of distributor equipment as well as application rate accuracy and uniformity of distribution shall be made when directed by the Resident Engineer. The truck used for sanding shall be equipped with a spreader that allows the sand to be uniformly distributed onto the pavement. The spreader shall be able to apply 1/2 pound to 3 pounds of sand per square yard in a single pass. The spreader shall be adjustable so as to not broadcast sand onto driveways or lawns. Any wet sand shall be rejected from the job site. Any equipment which is not maintained in full working order, or is proven inadequate to obtain the results prescribed, shall be repaired or replaced at the direction of the Resident Engineer.

APPLICATION OF REJUVENATING AGENT The asphalt rejuvenating agent shall be applied by a distributor truck at the temperature recommended by the manufacturer and at the pressure required for the proper distribution. The emulsion shall be so applied that uniform distribution is obtained at all points of the areas to be treated. Distribution shall be commenced with a running start to insure full rate of spread over the entire area to be treated. Areas inadvertently missed shall receive additional treatment as may be required by a hand sprayer application. Application of the asphalt rejuvenating agent shall be on one-half width of the pavement at a time. When the second half of the surface is treated, the nozzle nearest the center of the road shall overlap the previous by at least one-half the width of the nozzle spray. In any event the construction joint of the pavement shall be treated in both passes of the distributor truck. Before spreading, the asphalt rejuvenating agent shall be blended with water at the rate of two (2) parts rejuvenating agent to one (1) part water, by volume or as specified by the manufacturer. The combined mixture of asphalt rejuvenating agent and water shall be spread at the rate of 0.05 to 0.10 gallons per square yard, or as approved by the Resident Engineer following field testing. Where more than one application is to be made, succeeding applications shall be made as soon as penetration of the preceding application has been completed and approval is granted for additional applications by the Resident Engineer. Grades or super elevations of surfaces that may cause excessive runoff in the opinion of the Resident Engineer shall have the required amounts applied in two (2) or more applications as directed. After the road has been treated, the area within one foot of the curb line or edge line, as applicable, on both sides of the road shall receive an additional treatment of asphalt rejuvenating emulsion. Said treatment shall be uniformly applied by a

method acceptable to the Resident Engineer. Care should be taken during all rejuvenator applications to not get excessive material on the curb and gutter, where applicable. Additional cleaning may be required if this occurs at the contractor's expense. After the rejuvenating emulsion has penetrated, a coating of dry sand shall be applied to the surface in sufficient amount to protect the traveling public as required by the Resident Engineer. The Contractor shall furnish a quality inspection report showing the source, manufacturer, and the date shipped, for each load of asphalt rejuvenating agent. When directed by the Resident Engineer, the Contractor shall take representative samples of material for testing.

FIELD TESTING Prior to the application of the rejuvenator, ring tests shall be performed. Different rates of application shall be applied in each ring. The time it takes the rejuvenator to penetrate shall be recorded for each rate of application. Extrapolation shall then be used to determine the appropriate rate of application for the entire road.

ROAD SWEEPING The Contractor shall be responsible for sweeping and cleaning of the roads prior to and after treatment. Prior to treatment, the road will be cleaned of all standing water, dirt, leaves, foreign materials, etc. This work shall be accomplished by hand brooming, power blowing or other methods approved by the Resident Engineer. If hand cleaning is not sufficient, then a self-propelled road sweeper shall be used. All sand used during the treatment must be removed no later than forty-eight (48) hours after treatment of the road. This shall be accomplished by a combination of hand and mechanical sweeping. All turnouts, cul-de-sacs, etc. must be cleaned and free of any material that would interfere with the treatment. All debris generated by sweeping shall be picked up and disposed of by the contractor. Road sweeping shall be included in the price bid per square yard for asphalt rejuvenating agent. If after sand is swept and it is determined that a hazardous condition exists on the roadway, the Contractor must apply additional sand and sweep no later than twenty-four (24) hours following reapplication. No additional compensation will be allowed for reapplications and removal of sand.

TRAFFIC CONTROL & SAFETY The Contractor shall schedule his operations and carry out the work in a manner to cause the least disturbance and/or interference with the normal flow of traffic over the areas to be treated. Treated portions of the pavement surfaces shall be kept closed and free from traffic until penetration has become complete and the area is suitable for traffic. Cure time shall be no longer than 90 minutes. When traffic must be maintained at all times on a particular road, then the Contractor shall apply asphalt rejuvenating agent to one (1) lane at a time. Traffic shall be maintained in the untreated lane until the traffic may be switched to the completed lane. Access to adjacent properties shall be maintained during the application. The Contractor shall be responsible for all traffic control and signing required to permit safe travel. All signing and barricading of the work zone shall comply with MUTCD guidelines and IDOT standards. The Contractor shall notify the Resident Engineer as to the roads that are to be treated each day. All support vehicles used shall also have flashing beacons that can be seen from all sides of the vehicle, for safety considerations for all work on major arterials. If the Contractor fails to provide the required signing, the Contractor shall stop all operations until safe signing and barricading is achieved.

Any cost associated with this work or any and all traffic control standards included in this proposal shall be considered incidental to the pay items in this proposal.

SPREADING OF SAND OR SCREENINGS The contractor shall furnish all materials, equipment, tools, labor and incidentals necessary to perform the sanding operation in accordance with this contract.

Spreading shall consist of applying free flowing sharp sand, FA2 or limestone screenings to insure even distribution of the sand or screenings to be worked into any voids in the payment surface as directed by customer representative. A twin spinner, rubber belt feed system aggregate distributor shall be used for uniform application. The aggregate distributor shall apply sand or screenings at a rate of two pounds to four pounds per square yard for the restorative application.

Aggregate distributor must be able to carry enough aggregate to cover an applied load of the restoring agent, at least (9) nine tons. Repeated sanding may be required on some areas of pavement and contractor must be available on an as needed basis to provide the required sanding.

RESIDENT NOTIFICATION The contractor shall distribute by hand, a typed notice to all residences and businesses on the street to be treated. The notice will be delivered no more than 24 hours prior to the treatment of the road. The notice will have a local phone number that residents may call to ask questions. The notice shall be of the door hanger type which secures to the door handle of each dwelling. Unsecured notices will not be allowed. The contractor shall also place the notice on the windshield of any parked cars on the street.

BASIS OF PAYMENT Asphalt rejuvenating agent shall be measured by the square yard of material in place and will be paid for at the contract unit price for REJUVENATOR - RECLAMITE per square yard. Prices shall be full compensation for furnishing all materials, equipment, labor and incidentals to complete the work as specified and required.

REJUVENATOR – CRF

GENERAL SCOPE This work shall consist of furnishing all labor, material, and equipment necessary to perform all operations for the application of CRF Maltene-Based Restorative Seal to the surface of bituminous pavements as a restorative seal. The restoration of bituminous pavement surfaces shall be by spray application of a cationic restoring emulsion specially designed for this function. All work shall be in accordance with the requirements, the applicable drawings, and subject to the terms and conditions of these guidelines.

MATERIAL SPECIFICATIONS The emulsified asphalt restoring agent shall be an emulsion composed of a petroleum oils and asphalts uniformly emulsified with water. Each bidder must submit with his bid a certified statement from the asphalt restoring agent’s manufacturer showing that the emulsified product conforms to the requirements below:

Table 1 Maltene Based Emulsified Asphalt Restoring Agent Requirements		
Property	Test Method	Requirements
Viscosity, 25°C, SFS	ASTM D244	25-150
Sieve Test, w%	ASTM D244 (Mod) ¹	0.1 Max.
Particle Charge	ASTM D244	Positive
1-day Settlement, w%	ASTM D244	1.0 Max.
Residue, w%	ASTM D244 (Mod) ²	64.0 Min.
Tests on the Residue:		
Viscosity, 60°C, cSt	ASTM D2170	1000-4000
Maltene Distribution Ratio (Polar Compounds) + (First Acidaffins) (Saturates) + (Second Acidaffins)	ASTM D2006-70	0.7-1.1
Polar Compounds/Saturates Ratio	ASTM D2006-70	0.5 Min.
Asphaltenes, w%	ASTM D2006-70	14.0 Max.
¹ Test procedure identical with ASTM D244 except that distilled water shall be used in place of two percent sodium oleate solution. ² ASTM D244 Evaporation Test for percent residue is modified by heating a 50 gram sample to 149°C (300°F) until foaming ceases, then cooling immediately and calculating results.		

MATERIAL PERFORMANCE The restoring agent shall have a record of satisfactory service as an emulsified asphalt restoring agent and in-depth sealer. Satisfactory service shall be based on the capability of the material to decrease the viscosity and increase the penetration value of the asphalt binder as follows. The viscosity shall be reduced by a minimum of 20 percent and the penetration value shall be increased by a minimum of 15 percent. Testing shall be performed on extracted asphalt cement from a pavement to a depth of three eighths inch (3/8"). In addition, the pavement shall be in-depth sealed to the intrusion of air and water.

The bidder must submit with his bid the manufacturer's certification that the material proposed for use is in compliance with the emulsified asphalt restoring agent requirements.

APPLICATOR EXPERIENCE / PRE-QUALIFICATIONS Prior to submitting a bid, the prospective Contractor shall be prepared to provide a written statement of experience showing at least eight (8) projects of similar character that have been completed within the last year using the same rejuvenating emulsions that he is bidding on in this project. The prospective Contractor shall also submit a statement showing that they had at least five (5) years of experience using the same rejuvenating emulsions that they are bidding on, street and road applications only.

A project superintendent knowledgeable and experienced in application of the emulsified asphalt restoring agent must be in control of each day's work. The bidder shall submit a written experience outline of the project superintendent.

PRODUCT STANDARDS The product "CRF"® as previously manufactured by Witco Corporation-Golden Bear Oil is the standard for the emulsified asphalt restoring agent requirements and the prices quoted on the Bid Sheet Base Bid shall be for the "CRF"® standard.

APPLICATION TEMPERATURE/WEATHER LIMITATIONS The temperature of the emulsified asphalt restoring emulsion, at the time of application shall be as recommended by the manufacturer. The emulsified asphalt restoring agent shall be applied only when the existing surface to be treated is thoroughly dry and when it is not threatening to rain. The emulsified asphalt restoring agent shall not be applied when the ambient temperature is below 35° F.

HANDLING OF AN EMULSIFIED ASPHALT RESTORING AGENT When loading the distributor, the emulsified asphalt restoring agent concentrate shall be loaded first and then the required amount of water for dilution shall be added. The water shall be added into the distributor with enough force to cause agitation and thorough mixing of the two materials. To prevent foaming, the discharge end of the water hose or pipe shall be kept below the surface of the material in the distributor which shall be used as a spreader. Cleanliness of the spreading equipment shall be subject to the approval and satisfaction of the Engineer.

RESIDENT NOTIFICATION The contractor shall distribute by hand, a typed notice to all residences and businesses on the street to be treated. The notice will be delivered no more than 24 hours prior to the treatment of the road. The notice will have a local phone number that residents may call to ask questions. The notice shall be of the door hanger type which secures to the door handle of each dwelling. Unsecured notices will not be allowed. The contractor shall also place the notice on the windshield of any parked cars on the street.

APPLICATING EQUIPMENT The distributor for spreading the emulsion shall be self-propelled, and shall have pneumatic tires. The distributor shall be designed and equipped to distribute the emulsified asphalt restoring agent uniformly on variable widths of surface at readily determined and controlled rates from 0.05 to 0.5 gallons per square yard of surface, and with an allowable variation from any specified rate not to exceed 5 percent of the specified rate. Distributor equipment shall include full circulation spray bars, pump tachometer, volume measuring device and a hand hose attachment suitable for application of the emulsion manually to cover areas inaccessible to the distributor. The distributor shall be equipped to circulate and agitate the emulsion within the tank.

A check of the distributor equipment as well as application rate accuracy and uniformity of distribution shall be made when directed by the Engineer.

The truck used for sanding shall be equipped with a spreader that allows the sand to be uniformly distributed onto the pavement. The spreader shall be able to apply 2 to 6 pounds of sand per square yard in a single pass. The spreader shall be adjustable so as not to broadcast sand onto driveways or lawns.

The sand to be used shall be free flowing, without any leaves, dirt, stones, etc. Any wet sand shall be rejected from the job site.

Any equipment which is not maintained in full working order, or is proven inadequate to obtain the results prescribed, shall be repaired or replaced at the direction of the Engineer.

APPLICATION OF RESTORING AGENT The emulsified asphalt restoring agent shall be applied by a distributor truck at the temperature recommended by the manufacturer and at the pressure required for the proper distribution. The emulsion shall be so applied that uniform distribution is obtained at all points of the areas to be treated. Distribution shall be commenced with a running start to insure full rate of spread over the entire area to be treated. Areas inadvertently missed shall receive additional treatment as may be required by hand sprayer application.

Application of emulsified asphalt restoring agent shall be on one-half width of the pavement at a time. When the second half of the surface is treated, the distributor nozzle nearest the center of the road shall overlap the previous application by at least one-half the width of the nozzle spray.

Before spreading, the emulsified asphalt restoring agent shall be blended with water at the rate of 70% emulsified restoring agent to 30% part water, by volume or as specified by the manufacturer. The combined mixture of emulsified asphalt restoring agent and water shall be spread at the rate of 0.06 to 0.30 gallons per square yard, or as approved by the Engineer following field testing.

Where more than one application is to be made, succeeding applications shall be made as soon as penetration of the preceding application has been completed and approval is granted for additional applications by the Engineer.

Grades or super elevations of surfaces that may cause excessive runoff, in the opinion of the Engineer, shall have the required amounts applied in two or more applications as directed.

After the asphalt restoring emulsion has penetrated, a coating of dry sand shall be applied to the surface in sufficient amount to protect the traveling public as required by the Engineer.

The Contractor shall furnish a quality inspection report showing the source and manufacturer for the asphalt restoring agent. When directed by the Engineer, the Contractor shall take representative samples of material for testing.

SPREADING OF SAND OR SCREENINGS The contractor shall furnish all materials, equipment, tools, labor and incidentals necessary to perform the sanding operation in accordance with this contract.

Spreading shall consist of applying free flowing sharp sand, FA2 or limestone screenings to insure even distribution of the sand or screenings to be worked into any voids in the payment surface as directed by customer representative. A twin spinner, rubber belt feed system aggregate distributor shall be used for uniform application. The aggregate distributor shall apply sand or screenings at a rate of two pounds to four pounds per square yard for the restorative application.

Aggregate distributor must be able to carry enough aggregate to cover an applied load of the restoring agent, at least (9) nine tons. Repeated sanding may be required on some areas of pavement and contractor must be available on an as needed basis to provide the required sanding.

STREET SWEEPING The Contractor shall be responsible for sweeping and cleaning of the streets prior to, and after treatment.

Prior to treatment, the street will be cleaned of all standing water, dirt, leaves, foreign materials, etc. This work shall be accomplished by hand brooming, power blowing or other approved methods. If in the opinion of the Engineer, the hand cleaning is not sufficient then a self-propelled street sweeper shall be used.

All sand used during the treatment must be removed no later than 5 days after treatment of the street or as approved by the engineer. This shall be accomplished by a combination of hand and mechanical sweeping. All turnouts, cul-de-sacs, etc. must be cleaned of any material to the satisfaction of the Engineer. Street sweeping will be included in the price bid per square yard for asphalt rejuvenating agent.

If, after sand is swept and in the opinion of the Engineer a hazardous condition exists on the roadway, the contractor must apply additional sand and sweep same no later than 5 days following reapplication. No additional compensation will be allowed for reapplications and removal of sand.

TRAFFIC CONTROL The Contractor shall schedule his operations and carry out the work in a manner to cause the least disturbance and/or interference with the normal flow of traffic over the areas to be treated. Treated portions of the pavement surfaces shall be kept closed and free from traffic until penetration, in the opinion of the Engineer, has become complete and the area is suitable for traffic.

When, in the opinion of the Engineer, traffic must be maintained at all times on a particular street, then the Contractor shall apply the diluted asphalt restoring agent to one lane at a time. Traffic shall be maintained in the untreated lane until the traffic may be switched to the completed lane.

The Contractor shall be responsible for all traffic control and signing required to permit safe travel. The contractor shall notify the police and fire departments as to the streets that are to be treated each day.

If, in the opinion of the Engineer, proper signing is not being used, the Contractor shall stop all operations until safe signing and barricading is achieved.

METHOD OF MEASUREMENT The emulsified asphalt restoring agent will be measured by the square yard as provided for in the Contract Documents.

State of Illinois
Department of Transportation
Bureau of Local Roads and Streets

SPECIAL PROVISION
FOR
INSURANCE

Effective: February 1, 2007
Revised: August 1, 2007

All references to Sections or Articles in this specification shall be construed to mean specific Section or Article of the Standard Specifications for Road and Bridge Construction, adopted by the Department of Transportation.

The Contractor shall name the following entities as additional insured under the Contractor's general liability insurance policy in accordance with Article 107.27:

DeKalb County

Mayfield Township Road District

The entities listed above and their officers, employees, and agents shall be indemnified and held harmless in accordance with Article 107.26.

BDE SPECIAL PROVISIONS
For the April 24 and June 12, 2015 Lettings

The following special provisions indicated by an "x" are applicable to this contract and will be included by the Project Development and Implementation Section of the BD&E. An * indicates a new or revised special provision for the letting.

<u>File Name</u>	<u>#</u>	<u>Special Provision Title</u>	<u>Effective</u>	<u>Revised</u>
80240	1	Above Grade Inlet Protection	July 1, 2009	Jan. 1, 2012
80099	2	Accessible Pedestrian Signals (APS)	April 1, 2003	Jan. 1, 2014
80274	3	Aggregate Subgrade Improvement	April 1, 2012	Jan. 1, 2013
80192	4	Automated Flagger Assistance Device	Jan. 1, 2008	
80173	5	Bituminous Materials Cost Adjustments	Nov. 2, 2006	Aug. 1, 2013
80241	6	Bridge Demolition Debris	July 1, 2009	
50261	7	Building Removal-Case I (Non-Friable and Friable Asbestos)	Sept. 1, 1990	April 1, 2010
50481	8	Building Removal-Case II (Non-Friable Asbestos)	Sept. 1, 1990	April 1, 2010
50491	9	Building Removal-Case III (Friable Asbestos)	Sept. 1, 1990	April 1, 2010
50531	10	Building Removal-Case IV (No Asbestos)	Sept. 1, 1990	April 1, 2010
80310	11	Coated Galvanized Steel Conduit	Jan. 1, 2013	Jan. 1, 2015
80341	12	Coilable Nonmetallic Conduit	Aug. 1, 2014	Jan. 1, 2015
80198	13	Completion Date (via calendar days)	April 1, 2008	
80199	14	Completion Date (via calendar days) Plus Working Days	April 1, 2008	
* 80293	15	Concrete Box Culverts with Skews > 30 Degrees and Design Fills ≤ 5 Feet	April 1, 2012	April 1, 2015
80294	16	Concrete Box Culverts with Skews ≤ 30 Degrees Regardless of Design Fill and Skews > 30 Degrees with Design Fills > 5 Feet	April 1, 2012	April 1, 2014
80311	17	Concrete End Sections for Pipe Culverts	Jan. 1, 2013	
80334	18	Concrete Gutter, Curb, Median, and Paved Ditch	April 1, 2014	Aug. 1, 2014
80277	19	Concrete Mix Design – Department Provided	Jan. 1, 2012	Jan. 1, 2014
80261	20	Construction Air Quality – Diesel Retrofit	June 1, 2010	Nov. 1, 2014
80335	21	Contract Claims	April 1, 2014	
* 80029	22	Disadvantaged Business Enterprise Participation	Sept. 1, 2000	Jan. 2, 2015
* 80358	23	Equal Employment Opportunity	April 1, 2015	
80265	24	Friction Aggregate	Jan. 1, 2011	Nov. 1, 2014
80229	25	Fuel Cost Adjustment	April 1, 2009	July 1, 2009
80329	26	Glare Screen	Jan. 1, 2014	
80304	27	Grooving for Recessed Pavement Markings	Nov. 1, 2012	Aug. 1, 2014
80246	28	Hot-Mix Asphalt – Density Testing of Longitudinal Joints	Jan. 1, 2010	April 1, 2012
80322	29	Hot-Mix Asphalt – Mixture Design Composition and Volumetric Requirements	Nov. 1, 2013	Nov. 1, 2014
80323	30	Hot-Mix Asphalt – Mixture Design Verification and Production	Nov. 1, 2013	Nov. 1, 2014
* 80347	31	Hot-Mix Asphalt – Pay for Performance Using Percent Within Limits – Jobsite Sampling	Nov. 1, 2014	April 1, 2015
80348	32	Hot-Mix Asphalt – Prime Coat	Nov. 1, 2014	
80315	33	Insertion Lining of Culverts	Jan. 1, 2013	Nov. 1, 2013
80351	34	Light Tower	Jan. 1, 2015	
80336	35	Longitudinal Joint and Crack Patching	April 1, 2014	
* 80324	36	LRFD Pipe Culvert Burial Tables	Nov. 1, 2013	April 1, 2015
* 80325	37	LRFD Storm Sewer Burial Tables	Nov. 1, 2013	April 1, 2015
80045	38	Material Transfer Device	June 15, 1999	Aug. 1, 2014
80342	39	Mechanical Side Tie Bar Inserter	Aug. 1, 2014	Jan. 1, 2015
80165	40	Moisture Cured Urethane Paint System	Nov. 1, 2006	Jan. 1, 2010
80337	41	Paved Shoulder Removal	April 1, 2014	
80349	42	Pavement Marking Blackout Tape	Nov. 1, 2014	
80298	43	Pavement Marking Tape Type IV	April 1, 2012	

<u>File Name</u>	<u>#</u>	<u>Special Provision Title</u>	<u>Effective</u>	<u>Revised</u>
80254	44	Pavement Patching	Jan. 1, 2010	
80352	45	Pavement Striping - Symbols	Jan. 1, 2015	
* 80359	46	Portland Cement Concrete Bridge Deck Curing	April 1, 2015	
* 80353	47	Portland Cement Concrete Inlay or Overlay	Jan. 1, 2015	April 1, 2015
80338	48	Portland Cement Concrete Partial Depth Hot-Mix Asphalt Patching	April 1, 2014	
80343	49	Precast Concrete Handhole	Aug. 1, 2014	
80300	50	Preformed Plastic Pavement Marking Type D - Inlaid	April 1, 2012	
80328	51	Progress Payments	Nov. 2, 2013	
34261	52	Railroad Protective Liability Insurance	Dec. 1, 1986	Jan. 1, 2006
80157	53	Railroad Protective Liability Insurance (5 and 10)	Jan. 1, 2006	
80306	54	Reclaimed Asphalt Pavement (RAP) and Reclaimed Asphalt Shingles (RAS)	Nov. 1, 2012	April 1, 2014
80350	55	Retroreflective Sheeting for Highway Signs	Nov. 1, 2014	
80327	56	Reinforcement Bars	Nov. 1, 2013	
80344	57	Rigid Metal Conduit	Aug. 1, 2014	
* 80354	58	Sidewalk, Corner, or Crosswalk Closure	Jan. 1, 2015	April 1, 2015
80340	59	Speed Display Trailer	April 2, 2014	
80127	60	Steel Cost Adjustment	April 2, 2004	April 1, 2009
80317	61	Surface Testing of Hot-Mix Asphalt Overlays	Jan. 1, 2013	
80355	62	Temporary Concrete Barrier	Jan. 1, 2015	
80301	63	Tracking the Use of Pesticides	Aug. 1, 2012	
80356	64	Traffic Barrier Terminals Type 6 or 6B	Jan. 1, 2015	
20338	65	Training Special Provisions	Oct. 15, 1975	
80318	66	Traversable Pipe Grate	Jan. 1, 2013	April 1, 2014
* 80345	67	Underpass Luminaire	Aug. 1, 2014	April 1, 2015
80357	68	Urban Half Road Closure with Mountable Median	Jan. 1, 2015	
* 80346	69	Waterway Obstruction Warning Luminaire	Aug. 1, 2014	April 1, 2015
80288	70	Warm Mix Asphalt	Jan. 1, 2012	Nov. 1, 2014
80302	71	Weekly DBE Trucking Reports	June 2, 2012	
80289	72	Wet Reflective Thermoplastic Pavement Marking	Jan. 1, 2012	
80071	73	Working Days	Jan. 1, 2002	

The following special provisions are in the 2015 Supplemental Specifications and Recurring Special Provisions:

<u>File Name</u>	<u>Special Provision Title</u>	<u>New Location</u>	<u>Effective</u>	<u>Revised</u>
80292	Coarse Aggregate in Bridge Approach Slabs/Footings	Articles 1004.01(b) and 1004.02(f)	April 1, 2012	April 1, 2013
80303	Granular Materials	Articles 1003.04, 1003.04(c), and 1004.05(c)	Nov. 1, 2012	
80330	Pavement Marking for Bike Symbol	Article 780.14	Jan. 1, 2014	
80331	Payrolls and Payroll Records	Recurring CS #1 and #5	Jan. 1, 2014	
80332	Portland Cement Concrete – Curing of Abutments and Piers	Article 1020.13	Jan. 1, 2014	
80326	Portland Cement Concrete Equipment	Article 1103.03(a)(5)	Nov. 1, 2013	
80281	Quality Control/Quality Assurance of Concrete Mixtures	Recurring CS #31	Jan. 1, 2012	Jan. 1, 2014
80283	Removal and Disposal of Regulated Substances	Articles 669.01, 669.08, 669.09, 669.14, and 669.16	Jan. 1, 2012	Nov. 2, 2012
80319	Removal and Disposal of Surplus Materials	Article 202.03	Nov. 2, 2012	
80307	Seeding	Article 250.07	Nov. 1, 2012	
80339	Stabilized Subbase	Article 312.06	April 1, 2014	
80333	Traffic Control Setup and Removal Freeway/Expressway	Articles 701.18(l) and 701.19(a)	Jan. 1, 2014	

The following special provisions require additional information from the designer. The additional information needs to be included in a separate document attached to this check sheet. The Project Development and Implementation section will then include the information in the applicable special provision. The Special Provisions are:

- Bridge Demolition Debris
- Building Removal-Case I
- Building Removal-Case II
- Building Removal-Case III
- Building Removal-Case IV
- Completion Date
- Completion Date Plus Working Days
- DBE Participation
- Material Transfer Device
- Railroad Protective Liability Insurance
- Training Special Provisions
- Working Days

De Kalb County Prevailing Wage for February 2015

(See explanation of column headings at bottom of wages)

Trade Name	RG	TYP	C	Base	FRMAN	M-F>8	OSA	OSH	H/W	Pensn	Vac	Trng			
ASBESTOS ABT-GEN		BLD		31.130	32.130	1.5	1.5	2.0	8.240	14.14	0.000	0.800			
ASBESTOS ABT-MEC		BLD		35.100	37.600	1.5	1.5	2.0	11.17	10.76	0.000	0.720			
BOILERMAKER		BLD		44.240	48.220	2.0	2.0	2.0	6.970	17.54	0.000	0.350			
BRICK MASON		BLD		42.580	46.840	1.5	1.5	2.0	9.850	13.60	0.000	1.030			
CARPENTER		BLD		38.240	42.450	1.5	1.5	2.0	9.440	14.95	0.000	0.600			
CARPENTER		HWY		37.230	38.980	1.5	1.5	2.0	11.00	14.00	0.000	0.490			
CEMENT MASON		ALL		42.900	44.900	2.0	1.5	2.0	9.900	16.32	0.000	0.500			
CERAMIC TILE FNSHER		BLD		35.810	0.000	1.5	1.5	2.0	10.55	8.440	0.000	0.710			
COMMUNICATION TECH		BLD		36.440	40.080	1.5	1.5	2.0	10.39	12.09	0.000	0.760			
ELECTRIC PWR EQMT OP		ALL		37.890	51.480	1.5	1.5	2.0	5.000	11.75	0.000	0.380			
ELECTRIC PWR GRNDMAN		ALL		29.300	51.480	1.5	1.5	2.0	5.000	9.090	0.000	0.290			
ELECTRIC PWR LINEMAN		ALL		45.360	51.480	1.5	1.5	2.0	5.000	14.06	0.000	0.450			
ELECTRIC PWR TRK DRV		ALL		30.340	51.480	1.5	1.5	2.0	5.000	9.400	0.000	0.300			
ELECTRICIAN		BLD		42.960	47.260	1.5	1.5	2.0	10.39	17.47	0.000	0.860			
ELEVATOR CONSTRUCTOR		BLD		46.830	52.680	2.0	2.0	2.0	13.57	14.21	3.750	0.600			
FENCE ERECTOR	SE	ALL		45.060	48.660	2.0	2.0	2.0	10.52	18.81	0.000	0.400			
GLAZIER		BLD		35.980	37.980	1.5	1.5	1.5	10.30	8.200	0.000	1.250			
HT/FROST INSULATOR		BLD		48.450	50.950	1.5	1.5	2.0	11.47	12.16	0.000	0.720			
IRON WORKER	NW	ALL		36.290	38.100	2.0	2.0	2.0	8.640	22.69	0.000	0.500			
IRON WORKER	SE	ALL		45.060	48.660	2.0	2.0	2.0	10.52	18.81	0.000	0.400			
LABORER		BLD		31.130	32.130	1.5	1.5	2.0	8.240	14.14	0.000	0.800			
LABORER		HWY		33.560	34.310	1.5	1.5	2.0	8.240	16.39	0.000	0.800			
LABORER, SKILLED		HWY		36.160	36.910	1.5	1.5	2.0	8.240	16.39	0.000	0.800			
LATHER		BLD		38.240	42.450	1.5	1.5	2.0	9.440	14.95	0.000	0.600			
MACHINIST		BLD		44.350	46.850	1.5	1.5	2.0	6.760	8.950	1.850	0.000			
MARBLE MASON		BLD		41.780	45.960	1.5	1.5	2.0	9.850	13.42	0.000	0.760			
MATERIAL TESTER I		ALL		33.560	0.000	1.5	1.5	2.0	8.240	16.39	0.000	0.800			
MATERIALS TESTER II		ALL		33.560	0.000	1.5	1.5	2.0	8.240	16.39	0.000	0.800			
MILLWRIGHT		BLD		36.120	39.730	1.5	1.5	2.0	9.420	14.30	0.000	0.500			
OPERATING ENGINEER		BLD 1		42.800	46.800	2.0	2.0	2.0	17.10	11.05	2.350	1.300			
OPERATING ENGINEER		BLD 2		42.100	46.800	2.0	2.0	2.0	17.10	11.05	2.350	1.300			
OPERATING ENGINEER		BLD 3		39.650	46.800	2.0	2.0	2.0	17.10	11.05	2.350	1.300			
OPERATING ENGINEER		BLD 4		37.650	46.800	2.0	2.0	2.0	17.10	11.05	2.350	1.300			
OPERATING ENGINEER		BLD 5		46.550	46.800	2.0	2.0	2.0	17.10	11.05	2.350	1.300			
OPERATING ENGINEER		BLD 6		45.800	46.800	2.0	2.0	2.0	17.10	11.05	0.000	1.300			
OPERATING ENGINEER		BLD 7		42.800	46.800	2.0	2.0	2.0	17.10	11.05	0.000	1.300			
OPERATING ENGINEER		HWY 1		42.650	46.650	1.5	1.5	2.0	17.10	11.05	2.350	1.300			
OPERATING ENGINEER		HWY 2		42.100	46.650	1.5	1.5	2.0	17.10	11.05	2.350	1.300			
OPERATING ENGINEER		HWY 3		40.800	46.650	1.5	1.5	2.0	17.10	11.05	2.350	1.300			
OPERATING ENGINEER		HWY 4		39.350	46.650	1.5	1.5	2.0	17.10	11.05	2.350	1.300			
OPERATING ENGINEER		HWY 5		37.900	46.650	1.5	1.5	2.0	17.10	11.05	2.350	1.300			
OPERATING ENGINEER		HWY 6		45.650	46.650	1.5	1.5	2.0	17.10	11.05	2.350	1.300			
OPERATING ENGINEER		HWY 7		45.650	46.650	1.5	1.5	2.0	17.10	11.05	2.350	1.300			
ORNAMNTL IRON WORKER	SE	ALL		45.060	48.660	2.0	2.0	2.0	10.52	18.81	0.000	0.400			
PAINTER		ALL		41.730	43.730	1.5	1.5	1.5	10.30	8.200	0.000	1.350			
PAINTER SIGNS		BLD		33.920	38.090	1.5	1.5	1.5	2.600	2.710	0.000	0.000			
PILEDRIIVER		BLD		38.240	42.450	1.5	1.5	2.0	9.440	14.95	0.000	0.600			
PILEDRIIVER		HWY		37.230	38.980	1.5	1.5	2.0	11.00	14.00	0.000	0.490			
PIPEFITTER		BLD		46.000	49.000	1.5	1.5	2.0	9.000	15.85	0.000	1.780			
PLASTERER		BLD		42.250	44.790	1.5	1.5	2.0	11.40	12.19	0.000	0.650			
PLUMBER		BLD		46.650	48.650	1.5	1.5	2.0	13.18	11.46	0.000	0.880			
ROOFER		BLD		40.100	43.100	1.5	1.5	2.0	8.280	10.54	0.000	0.530			
SHEETMETAL WORKER		BLD		37.930	40.210	1.5	1.5	2.0	6.000	16.92	0.520	0.290			
SPRINKLER FITTER		BLD		37.120	39.870	1.5	1.5	2.0	8.420	8.500	0.000	0.350			
STEEL ERECTOR	SE	ALL		45.060	48.660	2.0	2.0	2.0	10.52	18.81	0.000	0.400			
STONE MASON		BLD		42.580	46.840	1.5	1.5	2.0	9.850	13.60	0.000	1.030			
SURVEY WORKER	---	NOT IN EFFECT				ALL	35.650	36.400	1.5	1.5	2.0	8.240	13.95	0.000	0.800
TERRAZZO FINISHER		BLD		37.040	0.000	1.5	1.5	2.0	10.55	10.32	0.000	0.620			
TERRAZZO MASON		BLD		40.880	43.880	1.5	1.5	2.0	10.55	11.63	0.000	0.820			
TILE LAYER		BLD		38.240	42.450	1.5	1.5	2.0	9.440	14.95	0.000	0.600			
TILE MASON		BLD		42.840	46.840	1.5	1.5	2.0	10.55	10.42	0.000	0.920			
TRUCK DRIVER		ALL 1		32.550	33.100	1.5	1.5	2.0	6.500	4.350	0.000	0.000			
TRUCK DRIVER		ALL 2		32.700	33.100	1.5	1.5	2.0	6.500	4.350	0.000	0.000			
TRUCK DRIVER		ALL 3		32.900	33.100	1.5	1.5	2.0	6.500	4.350	0.000	0.000			
TRUCK DRIVER		ALL 4		33.100	33.100	1.5	1.5	2.0	6.500	4.350	0.000	0.000			
TUCKPONTER		BLD		42.800	43.800	1.5	1.5	2.0	8.180	12.66	0.000	0.650			

Legend: RC (Region)
 TYP (Trade Type - All, Highway, Building, Floating, Oil & Chip, Rivers)
 C (Class)
 Base (Base Wage Rate)
 FRMAN (Foreman Rate)
 M-P>8 (OT required for any hour greater than 8 worked each day, Mon through Fri.)
 OSA (Overtime (OT) is required for every hour worked on Saturday)
 OSH (Overtime is required for every hour worked on Sunday and Holidays)
 H/W (Health & Welfare Insurance)
 Pensi (Pension)
 Vac (Vacation)
 Trng (Training)

Explanations

DEKALB COUNTY

IRONWORKERS (NORTHWEST) - That portion of the county from a point where the western county line intersects with Rt. 30, continuing eastward to Shabbona, north between Shabbona and Clare, and northeast between Clare and New Lebanon.

The following list is considered as those days for which holiday rates of wages for work performed apply: New Years Day, Memorial Day, Fourth of July, Labor Day, Thanksgiving Day, Christmas Day and Veterans Day in some classifications/counties. Generally, any of these holidays which fall on a Sunday is celebrated on the following Monday. This then makes work performed on that Monday payable at the appropriate overtime rate for holiday pay. Common practice in a given local may alter certain days of celebration. If in doubt, please check with IDOL.

EXPLANATION OF CLASSES

ASBESTOS - GENERAL - removal of asbestos material/mold and hazardous materials from any place in a building, including mechanical systems where those mechanical systems are to be removed. This includes the removal of asbestos materials/mold and hazardous materials from ductwork or pipes in a building when the building is to be demolished at the time or at some close future date.

ASBESTOS - MECHANICAL - removal of asbestos material from mechanical systems, such as pipes, ducts, and boilers, where the mechanical systems are to remain.

CERAMIC TILE FINISHER

The grouting, cleaning, and polishing of all classes of tile, whether for interior or exterior purposes, all burned, glazed or unglazed products; all composition materials, granite tiles, warning detectable tiles, cement tiles, epoxy composite materials, pavers, glass, mosaics, fiberglass, and all substitute materials, for tile made in tile-like units; all mixtures in tile like form of cement, metals, and other materials that are for and intended for use as a finished floor surface, stair treads, promenade roofs, walks, walls, ceilings, swimming pools, and all other places where tile is to form a finished interior or exterior. The mixing of all setting mortars including but not limited to thin-set mortars, epoxies, wall mud, and any other sand and cement mixtures or adhesives when used in the preparation, installation, repair, or maintenance of tile and/or similar materials. The handling and unloading of all sand, cement, lime, tile, fixtures, equipment, adhesives, or any other materials to be used in the preparation, installation, repair, or maintenance of tile and/or similar materials. Ceramic Tile Finishers shall fill all joints and voids regardless of method on all tile work, particularly and especially after installation of said tile work. Application of any and all protective coverings to all types of tile installations including, but not be limited to, all soap compounds, paper products, tapes, and all polyethylene coverings, plywood, masonite, cardboard, and any new type of products that may be used to protect tile installations, Blastrac equipment, and all floor scarifying equipment used in preparing floors to receive tile. The clean up and removal of all waste and materials. All demolition of existing tile floors and walls to be re-tiled.

COMMUNICATIONS TECHNICIAN

Installing, manufacturing, assembling and maintaining sound and intercom, protection alarm (security), fire alarm, master antenna television, closed circuit television, low voltage control for computers and/or door monitoring, school communications systems, telephones and servicing of nurse and emergency calls, and the installation and maintenance of transmit and receive antennas, transmitters, receivers, and associated apparatus which operates in conjunction with above systems. All work associated with these system installations will be included EXCEPT the installation of protective

metallic conduit in new construction projects (excluding less than ten-foot, runs strictly for protection of cable) and 120 volt AC (or higher) power wiring and associated hardware.

LABORER, SKILLED - HIGHWAY

Individuals engaged in the following types of work, irrespective of the site of the work: asbestos abatement worker, handling of any materials with any foreign matter harmful to skin or clothing, track laborer, cement handlers, chloride handlers, the unloading and loading with steel workers and re-bars, concrete workers wet, tunnel helpers in free air, batch dumpers, mason tenders, kettle and tar men, tank cleaners, plastic installers, scaffold workers, motorized buggies or motorized unit used for wet concrete or handling of building materials, laborers with de-watering systems, sewer workers plus depth, rod and chainmen with technical engineers, rod and chainmen with land surveyors, rod and chainmen with surveyors, vibrator operators, cement silica, clay, fly ash, lime and plasters, handlers (bulk or bag), cofferdam workers plus depth, on concrete paving, placing, cutting and tying of reinforcing, deck hand, dredge hand, and shore laborers, bankmen on floating plant, grade checker, power tools, front end man on chip spreaders, cession workers plus depth, gunnite nozzle men, lead man on sewer work, welders, cutters, burners and torchmen, chainsaw operators, jackhammer and drill operators, layout man and/or drainage tile layer, steel form setter - street and highway, air tamping hammermen, signal man on crane, concrete saw operator, screedman on asphalt pavers, laborers tending masons with hot material or where foreign materials are used, mortar mixer operators, multiple concrete duct - leadsman, lumen, asphalt raker, curb asphalt machine operator, ready mix scalemen (permanent, portable or temporary plant), laborers handling masterplate or similar materials, laser beam operator, concrete burning machine operator, coring machine operator, plaster tender, underpinning and shoring of buildings, pump men, manhole and catch basin, dirt and stone tamper, hose men on concrete pumps, hazardous waste worker, lead base paint abatement worker, lining of pipe, refusing machine, assisting on direct boring machine, the work of laying watermain, fire hydrants, all mechanical joints to watermain work, sewer worker, and tapping water service and forced lift station mechanical worker.

MATERIAL TESTER I: Hand coring and drilling for testing of materials; field inspection of uncured concrete and asphalt.

MATERIAL TESTER II: Field inspection of welds, structural steel, fireproofing, masonry, soil, facade, reinforcing steel, formwork, cured concrete, and concrete and asphalt batch plants; adjusting proportions of bituminous mixtures.

OPERATING ENGINEERS - BUILDING

Class 1. Asphalt Plant; Asphalt Spreader; Autograde; Backhoes with Caisson Attachment; Batch Plant; Benoto (requires Two Engineers); Boiler and Throttle Valve; Caisson Rigs; Central Redi-Mix Plant; Combination Back Hoe Front End-loader Machine; Compressor and Throttle Valve; Concrete Breaker (Truck Mounted); Concrete Conveyor; Concrete Paver (over 27E cu. ft.); Concrete Paver (27 cu. ft. and under); Concrete Placer; Concrete Pump (Truck Mounted); Concrete Conveyor (Truck Mounted); Concrete Tower; Cranes, All; GCI and similar types (required two operators only); Cranes, Hammerhead; Creter Crane; Crusher, Stone, etc.; Derricks, All; Derricks, Traveling; Formless Curb and Gutter Machine; Grader, Elevating; Grouting Machines; Highlift Shovels or Front Endloader 2-1/4 yd. and over; Hoists, Elevators, outside type rack and pinion and similar machines; Hoists, one, two and three Drum; Hoists, Two Tugger One Floor; Hydraulic Backhoes; Hydraulic Boom Trucks; Hydro Vac (and similar equipment - excluding hose work and any sewer work); Locomotives, All; Lubrication Technlcian; Manipulators; Motor Patrol; Pile Drivers and Skid Rig; Post Hole Dlgger; Pre-Stress Machine; Pump Cretes Dual Ram; Pump Cretes: Squeeze Cretes - Screw Type Pumps, Gypsum Bulker and Pump; Raised and Blind Hole Drill; Rock Drill (self-propelled); Rock Drill - Truck Mounted; Roto Mill Grinder; Scoops - Tractor Drawn; Slipform Paver; Scrapers Prime Movers; Straddle Buggies; Tie Back Machine; Tractor with Boom and Side Boom; Trenching Machines.

Class 2. Bobcat (over 3/4 cu. yd.); Boilers; Brick Forklift; Broom, All Power Propelled; Bulldozers; Concrete Mixer (Two Bag and Over); Conveyor, Portable; Forklift Trucks; Highlift Shovels or Front Endloaders under 2-1/4 yd.; Hoists, Automatic; Hoists, Sewer Dragging Machine; Hoists, Tugger Single Drum; Laser Screed; Rollers, All; Steam Generators; Tractors, All; Tractor Drawn Vibratory Roller; Winch Trucks with "A" Frame.

Class 3. Air Compressor; Asphalt Spreader; Combination - Small Equipment Operator; Generators; Heaters, Mechanical; Hoists, Inside Elevators - (Rheostat Manual Controlled); Hydraulic Power Units (Pile Driving, Extracting, or Drilling - with a seat); Lowboys; Pumps, Over 3" (1 to 3 not to exceed total of 300 ft.); Pumps, Well Points; Welding Machines (2 through 5); Winches, 4 Small Electric Drill

Winches; Bobcat (up to and including 3/4 cu. yd.).

Class 4. Elevator push button with automatic doors; Hoists, Inside; Oilers; Brick Forklift.

Class 5. Assistant Craft Foreman

Class 6. Mechanics; Welders.

Class 7. Gradall

OPERATING ENGINEERS - HIGHWAY CONSTRUCTION

Class 1. Asphalt Plant; Asphalt Heater and Planer Combination; Asphalt Heater Scarfire; Asphalt Silo Tender; Asphalt Spreader; Autograder; ABG Paver; Backhoes with Caisson Attachment; Ballast Regulator; Belt Loader; Caisson Rigs; Car Dumper; Central Redi-Mix Plant; Backhoe w/shear attachments; Combination Backhoe Front Endloader Machine, (1 cu. yd. Backhoe Bucket or over or with attachments); Concrete Breaker (Truck Mounted); Concrete Conveyor; Concrete Paver over 27E cu. ft.; Concrete Placer; Concrete Tube Float; Cranes, all attachments; Cranes, Tower of all types; Creter Crane; Crusher, Stone, etc.; Derricks, All; Derrick Boats; Derricks, Traveling; Directional Boring Machine over 12"; Dredges; Formless Curb and Gutter Machine; Grader, Elevating; Grader, Motor Grader, Motor Patrol, Auto Patrol, Form Grader, Pull Grader, Subgrader; Guard Rail Post Driver Mounted; Hoists, One, Two and Three Drum; Hydraulic Backhoes; Hydro Vac, Self Propelled, Truck Mounted (excluding hose work and any sewer work); Lubrication Technician; Manipulators; Pile Drivers and Skid Rig; Pre-Stress Machine; Pump Cretos Dual Ram; Rock Drill - Crawler or Skid Rig; Rock Drill - Truck Mounted; Rock/Track Tamper; Roto Mill Grinder; Slip-Form Paver; Snow Melters; Soil Test Drill Rig (Truck Mounted); Straddle Buggies; GCI Crane; Hydraulic Telescoping Form (Tunnel); Tie Back Machine; Tractor Drawn Belt Loader; Tractor Drawn Belt Loader with attached pusher; Tractor with Boom; Tractaire with Attachments; Traffic Barrier Conveyor Machine; Ralsed or Blind Hole Drills; Trenching Machine (over 12"); Truck Mounted Concrete Pump with Boom; Truck Mounted Concrete Conveyor; Work Boat (no license required - 90 h.p. or above); Underground Boring and/or Mining Machines; Wheel Excavator; Widener (APSCO).

Class 2. Batch Plant; Bituminous Mixer; Boiler and Throttle Valve; Bulldozers; Car Loader Trailing Conveyors; Combination Backhoe Front Endloader Machine (less than 1 cu. yd. Backhoe Bucket or over or with attachments); Compressor and Throttle Valve; Compressor, Common Receiver (3); Concrete Breaker or Hydro Hammer; Concrete Grinding Machine; Concrete Mixer or Paver 7S Series to and including 27 cu. ft.; Concrete Spreader; Concrete Curing Machine, Burlap Machine, Belting Machine and Sealing Machine; Concrete Wheel Saw (large self-propelled - excluding walk-behinds and hand-held); Conveyor Muck Cars (Haglund or Similar Type); Drills, all; Finishing Machine - Concrete; Highlift Shovels or Front Endloader; Hoist - Sewer Dragging Machine; Hydraulic Boom Trucks (All Attachments); Hydro Blaster; All Locomotives, Dinky; Off-Road Hauling Units; Non-Self Loading Dump; Ejection Dump; Pump Cretos: Squeeze Cretos - Screw Type Pumps, Gypsum Bulker and Pump; Roller, Asphalt; Rotary Snow Plows; Rototiller, Seaman, etc., self-propelled; Scoops - Tractor Drawn; Self-Propelled Compactor; Spreader - Chip - Stone, etc.; Scraper; Scraper - Prime Mover in Tandem (Regardless of Size); Tank Car Heater; Tractors, Push, Pulling Sheeps Foot, Disc, Compactor, etc.; Tug Boats.

Class 3. Boilers; Brooms, All Power Propelled; Cement Supply Tender; Compressor, Common Receiver (2); Concrete Mixer (Two Bag and Over); Conveyor, Portable; Farm-Type Tractors Used for Mowing, Seeding, etc.; Fireman on Boilers; Forklift Trucks; Grouting Machine; Hoists, Automatic; Hoists, All Elevators; Hoists, Tugger Single Drum; Jeep Diggers; Low Boys; Pipe Jacking Machines; Post-Hole Digger; Power Saw, Concrete Power Driven; Pug Mills; Rollers, other than asphalt; Seed and Straw Blower; Steam Generators; Stump Machine; Winch Trucks with "A" Frame; Work Boats; Tamper - Form - Motor Driven.

Class 4. Air Compressor - Small and Large; Asphalt Spreader, Backend Man; Bobcat (Skid Steer) all; Brick Forklift; Combination - Small Equipment Operator; Directional Boring Machine up to 12"; Generators; Heaters, Mechanical; Hydraulic Power Unit (Pile Driving, Extracting, or Drilling); Hydro-Blaster; Light Plants, All (1 through 5); Pumps, over 3" (1 to 3 not to exceed a total of 300 ft.); Pumps, Well Points; Tractaire; Trencher 12" and under; Welding Machines (2 through 5); Winches, 4 Small Electric Drill Winches.

Class 5. Oilers and Directional Boring Machine Locator.

Class 6. Field Mechanics and Field Welders

Class 7. Gradall and machines of like nature.

SURVEY WORKER - Operated survey equipment including data collectors,

G.P.S. and robotic instruments, as well as conventional levels and transits.

TERRAZZO FINISHER

The handling of sand, cement, marble chips, and all other materials that may be used by the Mosaic Terrazzo Mechanic, and the mixing, grinding, grouting, cleaning and sealing of all Marble, Mosaic, and Terrazzo work, floors, base, stairs, and wainscoting by hand or machine, and in addition, assisting and aiding Marble, Masonic, and Terrazzo Mechanics.

TRUCK DRIVER - BUILDING, HEAVY AND HIGHWAY CONSTRUCTION

Class 1. Two or three Axle Trucks. A-frame Truck when used for transportation purposes; Air Compressors and Welding Machines, including those pulled by cars, pick-up trucks and tractors; Ambulances; Batch Gate Lockers; Batch Hopperman; Car and Truck Washers; Carry-alls; Fork Lifts and Hoisters; Helpers; Mechanics Helpers and Greasers; Oil Distributors 2-man operation; Pavement Breakers; Pole Trailer, up to 40 feet; Power Mower Tractors; Self-propelled Chip Spreader; Skipman; Slurry Trucks, 2-man operation; Slurry Truck Conveyor Operation, 2 or 3 man; Teamsters Unskilled dumpman; and Truck Drivers hauling warning lights, barricades, and portable toilets on the job site.

Class 2. Four axle trucks; Dump Crets and Adgetors under 7 yards; Dumpsters, Track Trucks, Euclids, Hug Bottom Dump Turnapulls or Turntrailers when pulling other than self-loading equipment or similar equipment under 16 cubic yards; Mixer Trucks under 7 yards; Ready-mix Plant Hopper Operator, and Winch Trucks, 2 Axles.

Class 3. Five axle trucks; Dump Crets and Adgetors 7 yards and over; Dumpsters, Track Trucks, Euclids, Hug Bottom Dump Turntrailers or turnapulls when pulling other than self-loading equipment or similar equipment over 16 cubic yards; Explosives and/or Fission Material Trucks; Mixer Trucks 7 yards or over; Mobile Cranes while in transit; Oil Distributors, 1-man operation; Pole Trailer, over 40 feet; Pole and Expandable Trailers hauling material over 50 feet long; Slurry trucks, 1-man operation; Winch trucks, 3 axles or more; Mechanic--Truck Welder and Truck Painter.

Class 4. Six axle trucks; Dual-purpose vehicles, such as mounted crane trucks with hoist and accessories; Foreman; Master Mechanic; Self-loading equipment like P.B. and trucks with scoops on the front.

Other Classifications of Work:

For definitions of classifications not otherwise set out, the Department generally has on file such definitions which are available. If a task to be performed is not subject to one of the classifications of pay set out, the Department will upon being contacted state which neighboring county has such a classification and provide such rate, such rate being deemed to exist by reference in this document. If no neighboring county rate applies to the task, the Department shall undertake a special determination, such special determination being then deemed to have existed under this determination. If a project requires these, or any classification not listed, please contact IDOL at 217-782-1710 for wage rates or clarifications.

LANDSCAPING

Landscaping work falls under the existing classifications for laborer, operating engineer and truck driver. The work performed by landscape plantsman and landscape laborer is covered by the existing classification of laborer. The work performed by landscape operators (regardless of equipment used or its size) is covered by the classifications of operating engineer. The work performed by landscape truck drivers (regardless of size of truck driven) is covered by the classifications of truck driver.